

Some Remarks about the Interaction Between Quantum Algebra and Representation Stability

by

Daniel Barter

A dissertation submitted in partial fulfillment
of the requirements for the degree of
Doctor of Philosophy
(Mathematics)
in the University of Michigan
2017

Doctoral Committee:

Professor Andrew Snowden, Chair
Professor Thomas Lam
Professor James T. Liu
Professor David E. Speyer

© Daniel Barter 2017

barter@umich.edu

ORCID iD: [0000-0002-6423-117X](https://orcid.org/0000-0002-6423-117X)

Acknowledgments

I want to thank my advisor Andrew Snowden. If he was concerned about his first student using string diagrams instead of conventional algebraic notation, he never showed it. He has also listened to all of my ideas over the past 3 years and provided invaluable feedback and guidance. Without his input, this thesis would probably not exist. He did a great job reading drafts and correcting my grammar. I also want to thank Philip Tosteson. We dreamed up many of the ideas in this thesis together. He has played a large part in shaping the way that I see mathematics. I cannot imagine what I would have done with my time in Ann Arbor if we didn't hang out every day. John Wiltshire-Gordon taught me to be a mathematician. We spent a lot of time together during my first three years in Ann Arbor and he taught me about representation theory and category theory. Moreover, John first outlined the theorem in chapter 5 to me, I just filled in the details. John is also the person that got me interested in computing. Hopefully, one day, I will be as good at it as he is. Visiting Corey Jones and Scott Morrison in 2016 played a big role in my mathematical development. They taught me about tensor categories and how to compute inside them using string diagrams. Without them, this thesis would be very different and less exciting. I want to thank David, James and Thomas for sitting on my thesis committee. Anna and Hobie have been great roommates for the past two years. They have made my life so much easier and I would not have been able to do this without their moral support. My family, Philip, Kerry and Rebecca are the reason I am here. They taught me that there is nothing more important than understanding things. Moreover, they always listen when things go wrong and try to make things better. Thank you. I want to thank all of my friends in Ann Arbor. You know who you are. I have enjoyed playing Frisbee with all of you.

TABLE OF CONTENTS

Acknowledgments	ii
Introduction	1
Chapter	
1 String Diagrams and Tensor Categories	4
1.1 A Physical Motivation for Braided Tensor Categories	5
1.2 Representations of $SL_2(\mathbb{C})$	6
1.3 Trivalent vertex diagrams and the $6j$ -symbols	13
1.4 Transitioning into the Braided World	18
1.5 Semi-Normal forms	20
1.6 The Ribbon Argument	25
2 Semi-Normal Forms and $6j$ Symbols	28
3 Minimal Model for the Quantum Symmetric Algebra	30
3.1 Morita Theory	30
3.2 Modules over Tensor Algebras	33
3.3 Modules over the quantum symmetric algebra	35
4 A Sufficient Condition for the Braid Group to Surject onto Endomorphism Algebras	38
4.1 The Affine Braid Group	38
4.2 The Sufficient Condition	41
5 Noetherianity and Rooted Trees	43
5.1 Motivation and previous work	43
5.2 Open problems	44
5.3 Rooted Trees	44
5.4 A relative version of Kruskal's tree Theorem	46
5.5 Proof of Main Theorem	51
Bibliography	53

Introduction

This thesis consists of five chapters. The first is an introduction to tensor categories and the graphical calculus which we use to compute inside them. Chapters two through five each contain an independent result proved during my time at the University of Michigan.

Chapter 1. It has long been known to researchers in category theory and physics that computations internal to a tensor category can be expressed using string diagrams up to isotopy. This observation goes back to Penrose in [Pen71]. Moreover, they are an important part of the book [Pen05]. Here is an example of a string diagram:

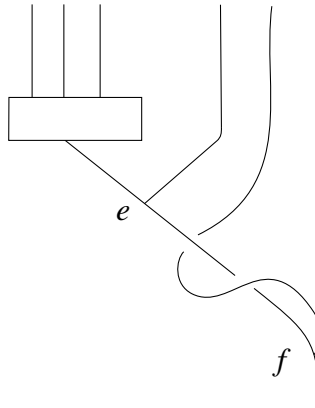

In Chapter 1, we explore the string diagram calculus and define $6j$ -symbols which are a coordinate representation of the associator in a tensor category. They will be important in later chapters.

In section 1.1, we describe the importance of braided tensor categories in topological quantum computing. In section 1.2 we introduce string diagrams in the context of $SL_2(\mathbb{C})$ -representations. In section 1.3, we introduce the trivalent vertex string diagrams which can be defined inside any tensor category. These trivalent vertices are to tensor categories as bases are to vector spaces. We also define the $6j$ -symbols, which are needed when computing with the trivalent vertex string diagrams. In section 1.4, we compute the symmetric and braided structures on the sub tensor category of $SL_2(\mathbb{C})$ -representations generated by the first fundamental representation. In section 1.5, we define semi-normal forms. These

generalize Young’s semi-normal form for simple reflections in the symmetric group. In section 1.6, we explain the ribbon argument which allows us to compute the action of the double braid on the trivalent string diagrams.

Chapter 2. The $6j$ -symbols contain a lot of information about their tensor category. Together with the fusion ring, they determine the tensor category upto equivalence. They are also useful from a computational perspective: many numbers which are of interest in low dimensional topology and quantum computing can be expressed in terms of $6j$ -symbols. Despite this, we only know explicit $6j$ -symbols in a small number of cases. In Chapter 2, we compute some new $6j$ -symbols in the category of polynomial $GL(\infty)$ -representations:

Theorem 1. *Let $\lambda \subseteq \mu$ be partitions such that $\mu \setminus \lambda$ has two boxes $(a_1, b_1), (a_2, b_2)$ not contained in a single row or column. Then*

$$(j_{\mu}^{\lambda, \square, \square})^{-1} = \begin{pmatrix} 1 + 1/d & -1 + 1/d \\ 1 & 1 \end{pmatrix}$$

where $d = |a_1 - a_2| + |b_1 - b_2|$ is the axial distance in the skew partition $\mu \setminus \lambda$.

A precise definition of the matrix j can be found in section 1.3. The fundamental idea is that Young semi-normal form encodes a large number of $6j$ -symbols. It is easy to compute explicit matrix representations of endomorphism algebras from $6j$ -symbols. We demonstrate that one can recover $6j$ -symbols from matrix representations.

Chapter 3. In this thesis, we use some of the tensor categorial machinery developed by the quantum algebra community to study algebraic objects which appear in representation stability. In [SS16], Sam and Snowden prove that the twisted commutative algebra Sym is Morita equivalent to the horizontal strip category. Their proof relies on a lemma proved by Olver in [Olv87]. In Chapter 3, we give a self contained proof that replaces Olver’s lemma with information about the associator in the underlying category of polynomial $GL(\infty)$ -representations. In fact, we prove a quantum analogue of the theorem. The classical version follows by letting the parameter converge to 1.

In section 3.1, we explain a mild generalization of classical Morita theory in which we replace objects with their presentations with respect to a family of projectives. In section 3.2, we study the tensor algebra generated by an object inside an arbitrary semi-simple tensor category. In section 3.3, we complete the proof that the quantum symmetric algebra is morita equivalent to the horizontal strip category.

Chapter 4. One of the central open problems in quantum algebra is to decide if the braid group representations coming from a braided tensor category are irreducible. This

problem is important in topological quantum computing. Modular tensor categories can be used to describe (2+1)-dimensional TQFTs. If the associated braid group representations are irreducible, then braiding gives us a universal set of quantum gates. In Chapter 4, we give a local condition for irreducibility, which appears to be new. Moreover, we give a simplified proof that skew representations of the symmetric group are irreducible for the affine action.

Chapter 5. Let \mathbf{FI} be the category of finite sets with injections. Finitely generated representations of \mathbf{FI} are Noetherian. This was proved independently by Church, Ellenberg and Farb in [CEF15] and by Snowden in [Sno13] and implies finiteness results for the cohomology of configuration spaces. Let \mathbf{T} be the category whose objects are rooted trees and morphisms are order embeddings preserving the root. In Chapter 5, we prove that finitely generated representations of \mathbf{T} are noetherian. The main ingredient in the proof is Kruskal's tree theorem. It would be interesting to find a category which is Noetherian as a result of the Graph minor theorem.

CHAPTER 1

String Diagrams and Tensor Categories

Tensor categories are ubiquitous in modern mathematics. In [ML98], one of the first books on category theory, a whole chapter is devoted to them. In the 90s, it was discovered that tensor categories provide a unifying framework for many interesting invariants in low-dimensional topology, for example the Jones polynomial. More recently, the quantum algebra community has been using tensor categories to describe (2+1)-dimensional topological quantum field theories. The book [Wan10] gives an overview and explains applications to topological quantum computation.

The modern theory of tensor categories is explained in [EGNO15], which is rigorous and self-contained, but does not explain the string diagram language that researchers use to discover and communicate computations. The author was lucky enough to learn how to use string diagrams from Scott Morrison and Corey Jones during a three week visit to the Australian National University and many video chat conversations.

Above, we referred to the *modern theory of tensor categories*. This requires some explanation. Historically, people studied Hopf algebras instead of their categories of representations. This is analogous to studying vector spaces by first choosing a basis: One can prove everything needed, but the theory is neither elegant nor easy to digest. The modern approach is to take the tensor category as the central object. From this perspective, Hopf algebras are equivalent (modulo technical details) to tensor functors into vector spaces. Such functors are plentiful and not the only way to study tensor categories. Hopf algebras still play a central role in constructing tensor categories, but they should be thought of as a tool rather than the central object of interest.

This chapter is meant to be expository. We are not going to describe the theory of tensor categories in a formal way. A rigorous and modern introduction can be found in [EGNO15]. Instead, we demonstrate how to use string diagrams as a tool for understanding tensor categories. The ideal reader is someone who knows the definition of a tensor category, but is otherwise skeptical of the abstraction. At first, we focus on finite dimensional $SL_2(\mathbb{C})$ -representations. Slowly, we transition from the $SL_2(\mathbb{C})$ case to the general case. There

is some overlap between this chapter and [CFS95], but we assume the reader understands the representation theory of $\mathrm{SL}_2(\mathbb{C})$, and we do not explicitly compute the $6j$ -symbols, although we explain what they are and why they are important.

1.1 A Physical Motivation for Braided Tensor Categories

In quantum theory, the state of a physical system is specified by a vector in a Hilbert space. Consider the following situation: We have n particles in \mathbb{R}^2 and each particle has some internal structure. If we treat the position of the particles classically, then the state of our system is specified by a point in a unitary vector bundle $H \rightarrow E \rightarrow C_n(\mathbb{R}^2)$ where $C_n(\mathbb{R}^2)$ is the configuration space of n distinct points in \mathbb{R}^2 and H is a finite dimensional Hilbert space. To specify the dynamics, we need to lift paths in $C_n(\mathbb{R}^2)$ to paths in E . More precisely, we need a unitary connection on E . We call the system topological if the chosen connection is flat. This means that small perturbations of the particles do not change their internal state, or equivalently, the curvature tensor of our chosen connection vanishes. Since $\pi_1(C_n(\mathbb{R}^2))$ is the braid group B_n , a flat unitary connection on E is specified by a unitary representation $B_n \curvearrowright H$.

If we take two such topological systems $B_n \curvearrowright H, B_m \curvearrowright K$ and combine them, we take the tensor product of the internal state spaces $H \otimes K$, and expect this Hilbert space to carry an action of B_{n+m} compatible with the $B_n \times B_m$ action. This is a strict condition on the braid group representations we want to consider.

We can construct compatible families of braid group representations in the following way: Let \mathbf{X} be a semi-simple braided tensor category and choose a distinguished object $X \in \mathbf{X}$. Then we have a family of compatible braid group representations $B_n \rightarrow \mathrm{End}(X^{\otimes n})$. These families are the main object of study in this thesis. Moreover, if we work with unitary braided tensor categories, the braid group actions are unitary, so they specify unitary connections. The tensor category captures more than just compatibility between braid group representations. The maps between objects in the tensor category encode how the quantum state transforms when particles interact. This is explained in [BH10].

From the physical perspective, one of the fundamental questions we can ask about a braid group representation $B_n \curvearrowright H$ is whether $\mathbb{C}[B_n] \rightarrow \mathrm{End}(H)$ is surjective. If this is the case, we get every unitary transformation $U : H \rightarrow H$ from the braid group action. As explained in [NC00], this implies that we can build quantum computers using systems which are modeled as above. These are called topological quantum computers. In Chapter 4 we give a new criteria for the surjectivity of $\mathbb{C}[B_n] \rightarrow \mathrm{End}(H)$ when H comes from a semi-simple braided tensor category. If we want to express quantum gates in terms of the

braid group, we need explicit formulas for the braid group representations coming from a braided tensor category. These matrix representations are encoded in the $6j$ -symbols which we define in this chapter.

1.2 Representations of $\mathrm{SL}_2(\mathbb{C})$

In this section, we describe, using string diagrams, the category $\mathrm{Rep}(\mathrm{SL}_2(\mathbb{C}))$, whose objects are finite dimensional representations of $\mathrm{SL}_2(\mathbb{C})$. We assume that the reader is already familiar with the representation theory of $\mathrm{SL}_2(\mathbb{C})$.

Definition 2. The algebraic group $\mathrm{SL}_2(\mathbb{C})$ is defined by

$$\mathrm{SL}_2(\mathbb{C}) = \left\{ \begin{pmatrix} a & b \\ c & d \end{pmatrix} : a, b, c, d \in \mathbb{C}, \quad ad - bc = 1 \right\}.$$

The standard representation is $V = \mathbb{C}^2 = \mathbb{C}\{e_1, e_2\}$ and $\mathrm{SL}_2(\mathbb{C})$ acts via left multiplication.

Theorem 3. *Finite dimensional representations of $\mathrm{SL}_2(\mathbb{C})$ are semi-simple. The irreducible representations are*

$$V_0 = \mathrm{Sym}^0(V) \quad V_1 = \mathrm{Sym}^1(V) \quad V_2 = \mathrm{Sym}^2(V) \quad V_3 = \mathrm{Sym}^3(V) \quad \dots$$

A proof of Theorem 3 can be found in [Ser01].

Definition 4. If W and X are representations of $\mathrm{SL}_2(\mathbb{C})$, then so is $W \otimes X$. The group action is defined by $g \cdot (w \otimes x) = gw \otimes gx$ on rank 1 tensors and extends linearly to the entire tensor product. The tensor flip $W \otimes X \rightarrow X \otimes W$ defined by $w \otimes x \mapsto x \otimes w$ intertwines the $\mathrm{SL}_2(\mathbb{C})$ action. We encapsulate these facts by saying that the category of $\mathrm{SL}_2(\mathbb{C})$ -representations is a **symmetric tensor category**. For a precise definition, see [EGNO15] or [ML98].

Recall that the character of V_n relative to the torus

$$\left\{ \begin{pmatrix} t & 0 \\ 0 & t^{-1} \end{pmatrix} \right\} \subseteq \mathrm{SL}_2(\mathbb{C})$$

is the polynomial $c_n = t^n + t^{n-2} + \dots + t^{2-n} + t^{-n}$. Since we have $c_1^2 = c_0 + c_2$, it follows that

$$V^{\otimes 2} \cong \mathbb{C} \oplus V_2.$$

Definition 5. In quantum algebra, we describe maps in a tensor category using **string diagrams**. The string diagram for the inclusion $\mathbb{C} \rightarrow V \otimes V$ is

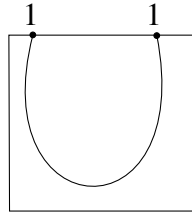

We can extract information from the string diagram as follows: If we read the dots along the top edge from left to right, we get the sequence $(1, 1)$. This tells us that the codomain is $V_1^{\otimes 2}$. If we read the dots along the bottom edge from left to right, we get the empty sequence $()$. This tells us the domain is \mathbb{C} . Therefore the string diagram specifies a morphism $\mathbb{C} \rightarrow V^{\otimes 2}$. There is a 1-dimensional space of such morphisms, so we need to choose a specific one. We take

$$\begin{array}{c} \text{1} \quad \text{1} \\ \square \\ \text{U-shaped string} \end{array} = \begin{pmatrix} 0 \\ i \\ -i \\ 0 \end{pmatrix}$$

where the basis on $V_1^{\otimes 2}$ is $\{e_1 \otimes e_1, e_1 \otimes e_2, e_2 \otimes e_1, e_2 \otimes e_2\}$. It is routine to check that this map is $SL_2(\mathbb{C})$ -equivariant. The string diagram for the inclusion $\text{Sym}^2(V) = V_2 \hookrightarrow V \otimes V$ is

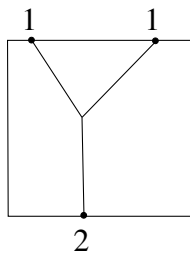

The sequence along the top edge is $(1, 1)$, indicating that the domain is $V_1 \otimes V_1$. The sequence along the bottom edge is (2) , indicating that the codomain is V_2 . Again, there is a

1-dimensional space of such morphisms, and we make the following choice:

$$= \begin{pmatrix} 1 & 0 & 0 \\ 0 & 1/2 & 0 \\ 0 & 1/2 & 0 \\ 0 & 0 & 1 \end{pmatrix}$$

We call the box the **boundary** of the string diagram. We call the dots on the boundary the **fixed points** of the string diagram. It is common to draw string diagrams without their boundary or fixed points. Often the fixed point labels are also omitted if they can be inferred from the context. Because we are optimists, we read from the bottom of the page to the top. We denote the pairing $V \otimes V \rightarrow \mathbb{C}$ with the following string diagram:

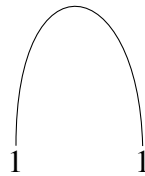

Again, there is a 1-dimensional space of such morphisms, so we take

$$= (0 \quad i \quad -i \quad 0)$$

as our specific pairing. Another important equivariant map $V \rightarrow V$ is the identity map. The corresponding string diagram is

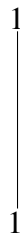

Definition 6. In a tensor category we can compose and tensor morphisms. In terms of

string diagrams, composition is vertical stacking:

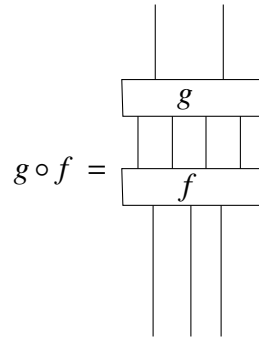

In this diagram we have omitted the boundary box, fixed points and string labels as explained in Definition 5. It is important to note that two string diagrams can be composed only when the fixed points and string labels match in the middle. This is equivalent to saying that $g \circ f$ is defined only when the domain of g equals the codomain of f . For string diagrams, tensor product is horizontal stacking:

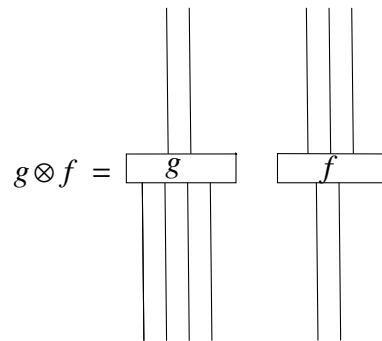

Unlike composition, we do not need to match fixed points and string labels for the tensor product.

Example 7. Let us look at some explicit computations in $\text{Rep}(\text{SL}_2(\mathbb{C}))$:

$$\bigcirc = (0 \ i \ -i \ 0)(0 \ i \ -i \ 0)^T = -2$$

$$\begin{array}{c} \cup \cup \\ \cap \end{array} = \begin{pmatrix} 0 & 0 & 0 & 0 \\ 0 & 0 & 0 & 0 \\ 0 & 0 & 0 & 0 \\ 0 & 0 & 0 & 0 \\ 0 & 0 & 0 & 0 \\ 0 & 0 & 0 & 0 \\ 0 & -i & i & 0 \\ 0 & i & -i & 0 \\ 0 & 0 & 0 & 0 \\ 0 & 0 & 0 & 0 \\ 0 & 0 & 0 & 0 \\ 0 & i & -i & 0 \\ 0 & -i & i & 0 \\ 0 & 0 & 0 & 0 \\ 0 & 0 & 0 & 0 \\ 0 & 0 & 0 & 0 \\ 0 & 0 & 0 & 0 \end{pmatrix}$$

$$\begin{array}{c} \cup \\ \cap \end{array} = \begin{pmatrix} 0 & 0 & 0 & 0 \\ 0 & -1 & 1 & 0 \\ 0 & 1 & -1 & 0 \\ 0 & 0 & 0 & 0 \end{pmatrix}$$

The last equation is interesting because it implies that

$$\begin{array}{c} | \\ | \end{array} + \begin{array}{c} \cup \\ \cap \end{array} = \begin{pmatrix} 1 & 0 & 0 & 0 \\ 0 & 0 & 1 & 0 \\ 0 & 1 & 0 & 0 \\ 0 & 0 & 0 & 1 \end{pmatrix}$$

which is the tensor flip $V \otimes V \rightarrow V \otimes V$. We introduce the following notation for the tensor flip:

$$\begin{array}{c} \diagdown \\ \diagup \end{array} = \begin{array}{c} | \\ | \end{array} + \begin{array}{c} \cup \\ \cap \end{array}$$

Addition of string diagrams corresponds to addition of linear maps. Note that we can only add string diagrams when the fixed points and fixed point labels match. Both compo-

sition and tensor product of string diagrams are bilinear. Consider the following equation:

$$\begin{array}{c} \text{U} \\ \text{U} \end{array} = \text{id} \otimes \begin{pmatrix} 0 & i & -i & 0 \end{pmatrix} \begin{pmatrix} 0 & i & -i & 0 \end{pmatrix}^T \otimes \text{id} = \begin{pmatrix} 1 & 0 \\ 0 & 1 \end{pmatrix}$$

The mirrored computation gives us

$$\begin{array}{c} \text{U} \\ \text{U} \end{array} = \begin{array}{c} \text{U} \\ \text{U} \end{array}$$

which seems to suggest that the equivariant map represented by a string diagram is an isotopy invariant. Here is another example:

$$\begin{array}{c} \text{K} \\ \text{K} \end{array} = \begin{pmatrix} 0 & i & 0 & 0 & -i & 0 & 0 & 0 \\ 0 & 0 & 0 & i & 0 & 0 & -i & 0 \end{pmatrix} = \begin{array}{c} \text{K} \\ \text{K} \end{array}$$

This is a special case of the following:

Theorem 8 (informal). *Morphisms in a $*$ tensor category, where $*$ is any of the usual adjectives (symmetric, braided, pivotal, ribbon), are described by string diagrams modulo isotopy relative to their boundary fixed points.*

In [JS91], Street and Joyal give a rigorous proof in some special cases. A more complete but informal discussion of Theorem 8 can be found in [Sel11]. Morally, Theorem 8 is a special case of the cobordism hypothesis which states that the (∞, n) -category of cobordisms is the free symmetric monoidal (∞, n) -category with duals generated by a single object. Details can be found in [Fre13]; we will not be pursuing that idea further. If our tensor category is realized as representations over a Hopf algebra, we can easily convert any string diagram equation into a matrix tensor equation which can be checked by hand

or in a computer. For example, Theorem 8 implies that

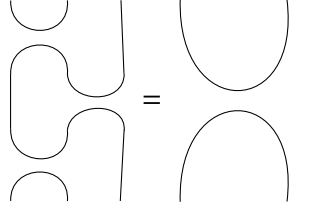

and it is easy to check that both sides are equal to the matrix

$$\begin{pmatrix} 0 & 0 & 0 & 0 & 0 & 0 & 0 & 0 \\ 0 & 0 & 0 & 0 & 0 & 0 & 0 & 0 \\ 0 & 0 & -1 & 0 & 1 & 0 & 0 & 0 \\ 0 & 0 & 0 & -1 & 0 & 1 & 0 & 0 \\ 0 & 0 & 1 & 0 & -1 & 0 & 0 & 0 \\ 0 & 0 & 0 & 1 & 0 & -1 & 0 & 0 \\ 0 & 0 & 0 & 0 & 0 & 0 & 0 & 0 \\ 0 & 0 & 0 & 0 & 0 & 0 & 0 & 0 \end{pmatrix}$$

This is a well known relation in the Temperley–Lieb algebra $\text{End}_{\text{SL}_2}(V^{\otimes 3})$.

As an application of the string diagrams we have seen so far, let us fully describe $\text{hom}_{\text{SL}_2}(V^{\otimes m}, V^{\otimes n})$. Since the first fundamental representation of $\text{SL}_2(\mathbb{C})$ is self dual, we have an isomorphism $\text{hom}_{\text{SL}_2}(V^{\otimes m}, V^{\otimes n}) \rightarrow \text{hom}_{\text{SL}_2}(V^{\otimes(m+n)}, \mathbb{C})$ defined by

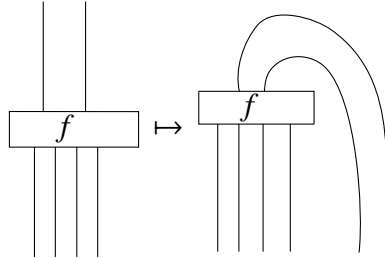

Therefore, it suffices to describe the invariant spaces $\text{hom}_{\text{SL}_2}(V^{\otimes n}, \mathbb{C})$ in terms of the string diagrams. Using characters, we can check that

$$\dim \text{hom}_{\text{SL}_2}(\mathbb{C}, V^{\otimes n}) = \begin{cases} 0 & n \text{ odd} \\ C_d & n = 2d \end{cases}$$

where C_d is the d th Catalan number. It is well known that there are C_d string diagrams with no crossings and $2d$ fixed points on the bottom boundary. These string diagrams are a basis

for $\text{hom}_{\text{SL}_2}(\mathbb{C}, V^{\otimes 2d})$. For example, when $d = 3$, the following diagrams form a basis:

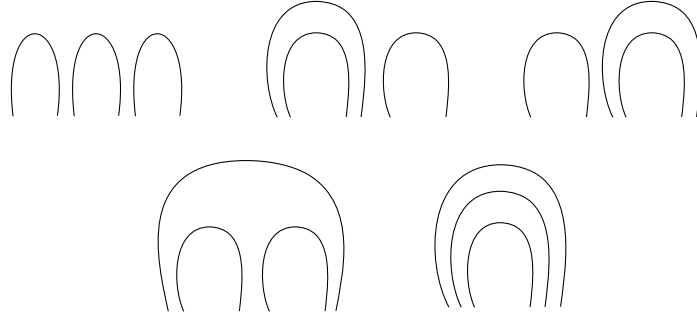

1.3 Trivalent vertex diagrams and the $6j$ -symbols

In Section 1.2, we used our understanding of $\text{SL}_2(\mathbb{C})$ to produce string diagrams. It turns out that we can produce a general set of **trivalent vertex string diagrams** in any semi-simple tensor category and they are the focus of this section.

Definition 9. Let \mathbf{X} be a semi-simple tensor category. Index the simple objects with a set Λ . Choose a basis for each $\mathbf{X}(\mu, \lambda \otimes \nu)$ denoted by

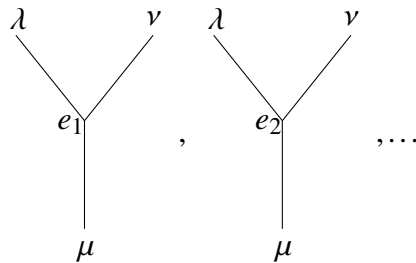

and let

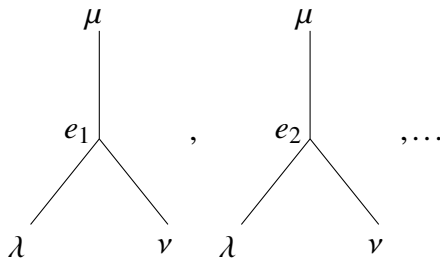

be the dual basis of $\mathbf{X}(\lambda \otimes \nu, \mu)$. We call these diagrams **trivalent vertices**. It is important to notice that trivalent vertices are not canonically defined.

Definition 10. Pick a distinguished simple object $X \in \mathbf{X}$. The **fusion graph** of X has vertices Λ and the edges from λ to μ are the distinguished basis vectors in $\mathbf{X}(\mu, \lambda \otimes X)$.

Proposition 11. Fix $\lambda \in \Lambda$. Then $\mathbf{X}(\lambda, X^{\otimes n})$ has dimension the number of paths from the tensor unit to λ in the fusion graph for X of length n . Moreover, an explicit basis is given by string diagrams of the form

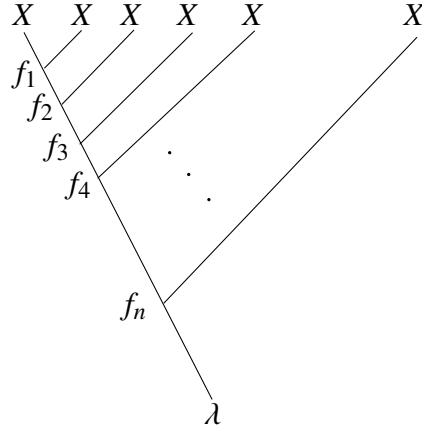

In this diagram, each f_i is a trivalent vertex of the form

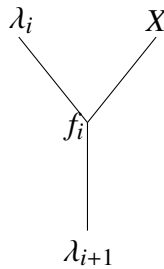

we call such string diagrams **trivalent basis vectors**

Proof. Decompose $X^{\otimes n}$ using the fusion graph for X . □

Definition 12. If \mathbf{X} is a semi-simple tensor category over \mathbb{C} with finite dimensional morphism spaces, the Artin-Wedderburn Theorem implies that $\text{End}(X^{\otimes n})$ is a product of matrix algebras. Proposition 11 implies that in the trivalent basis, the matrix units in $\text{End}(X^{\otimes n})$ look like

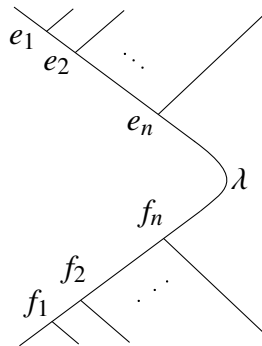

Equivalently, the irreducible representations of $\text{End}(X^{\otimes n})$ are parameterized by the simple objects in \mathbf{X} which have a length n path from the tensor unit in the fusion graph for X . The string diagrams defined in Proposition 11 form a basis for the corresponding representation.

Definition 13. Fix $\lambda_1, \lambda_2, \lambda_3, \mu \in \Lambda$. Then we have two bases for $\mathbf{X}(\mu, \lambda_1 \otimes \lambda_2 \otimes \lambda_3)$:

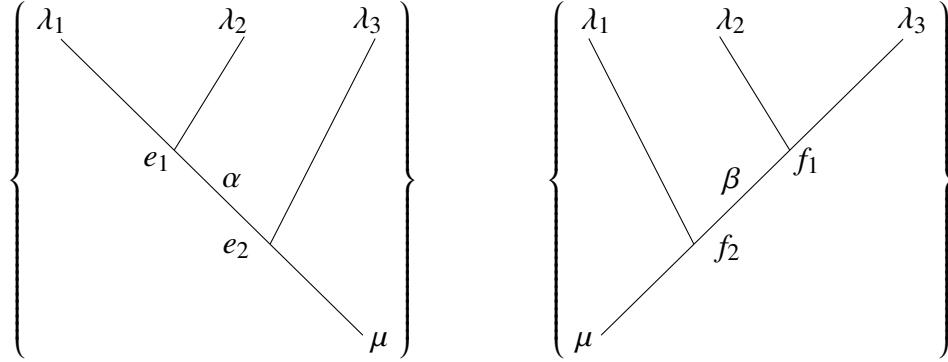

The $6j$ -symbols are the entries in the change of basis matrix $(j_{\mu}^{\lambda_1, \lambda_2, \lambda_3})_{f_1, f_2}^{e_1, e_2}$. In other words, they are a coordinate representation of the associator. They must satisfy some algebraic relations which correspond to the pentagon axiom and the unit axiom. From the $6j$ -symbols and the Grothendieck ring, we can recover the tensor category. Therefore, the $6j$ -symbols are coordinates on the moduli stack of semi-simple tensor categories with a fixed Grothendieck ring.

Example 14. Let G be a finite group. Consider a semi-simple tensor category over \mathbb{C} with Grothendieck ring $\mathbb{N}[G]$. We write V_g for the simple object corresponding to V_g . On objects, the tensor product is given by $V_g \otimes V_h = V_{gh}$. In order to fully specify the tensor category, we need to choose an associator:

$$V_{ghi} = (V_g \otimes V_h) \otimes V_i \cong V_g \otimes (V_h \otimes V_i) = V_{ghi}$$

Any such map is multiplication by a constant, therefore the associator is a function $a : G^3 \rightarrow$

\mathbb{C}^\times . The associator must satisfy the pentagon relation:

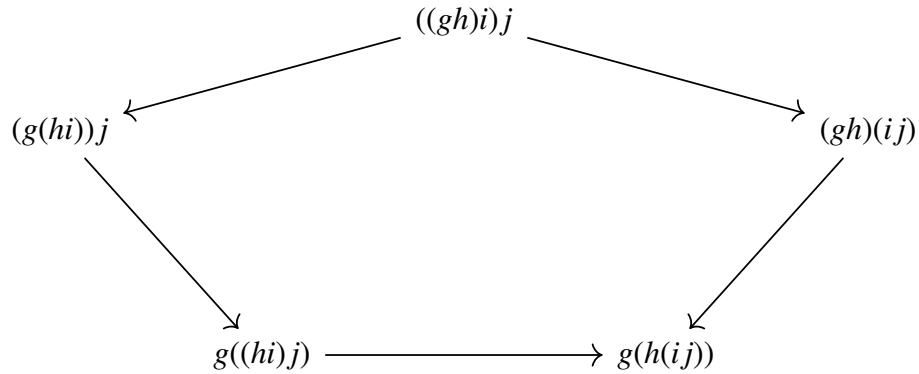

which implies that

$$a(g, h, i)a(g, h, ij)^{-1}a(g, hi, j)a(gh, i, j)^{-1}a(h, i, j) = 1.$$

Therefore the associator a defines a cohomology class in $H^3(G, \mathbb{C}^\times)$. Moreover, two associators give equivalent tensor categories if and only if their quotient is a coboundary. We can also construct tensor equivalences using automorphisms of G . Since conjugation acts trivially on group cohomology, the moduli space of semi-simple tensor categories with Grothendieck ring $\mathbb{N}[G]$ is $H^3(G, \mathbb{C}^\times)/\text{Out}(G)$.

Example 15. Let $\mathbf{X} = \text{Rep}(\text{SL}_2(\mathbb{C}))$ be the category of finite dimensional $\text{SL}_2(\mathbb{C})$ -representations and $X = V$ the first fundamental representation. We can check using characters that

$$\text{Sym}^n(V) \otimes V = \text{Sym}^{n-1}(V) \oplus \text{Sym}^{n+1}(V).$$

Therefore the fusion graph for V looks like



The endomorphism algebra $\text{End}(V^{\otimes n})$ is called the Temperley-Leib algebra, and we de-

scribed it in terms of string diagrams in section 1.2. In this example, we can take

which implies that

If we have explicit formulas for the $6j$ -symbols, then evaluating expressions like

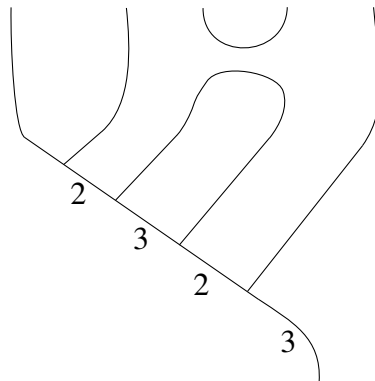

into the tree basis is reduced to an explicit computation: associate then evaluate then associate back. Therefore, if we have explicit formulas for the $6j$ -symbols, we get explicit matrix representations of the endomorphism algebras $\text{End}(X^{\otimes n})$. In the $\text{SL}_2(\mathbb{C})$ case, explicit formulas for the $6j$ -symbols are computed in [CFS95].

Example 16. Let $\mathbf{X} = \text{Rep}(G_2)$ be the category of finite dimensional G_2 -representations and $X = V$ be the first fundamental representation. The dominant integral weight lattice for G_2 looks like:

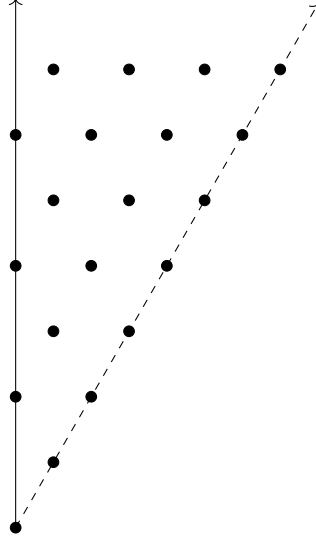

In the fusion graph, every vertex that is not on the solid vertical line has a self loop. Let d be the shortest distance between two different dominant integral weights. For every vertex, there is a directed edge to all vertices which are distance d away. For a generic vertex, there are seven outgoing edges, one of them a self loop.

1.4 Transitioning into the Braided World

Define $\mathbf{TL}(\delta)$ to be the tensor category generated by

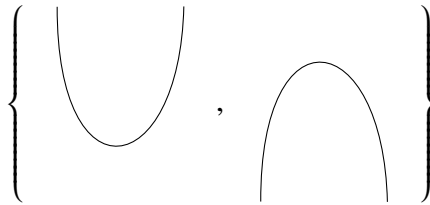

with the following relation:

$$\bigcirc = \delta$$

This is the free tensor category generated by a self dual object V such that the composition $k \rightarrow V \otimes V \rightarrow k$ is multiplication by the scalar δ . The category $\mathbf{TL}(-2)$ is equivalent to the sub-tensor category of $\mathrm{SL}_2(\mathbb{C})$ -representations generated by the first fundamental representation. Moreover, if we take the idempotent completion of $\mathbf{TL}(-2)$, we recover the category of all finite dimensional $\mathrm{SL}_2(\mathbb{C})$ -representations. It is natural to ask how many different symmetric structures exist on $\mathbf{TL}(-2)$.

Proposition 17. *Up to negation, the only symmetric structure on $\mathbf{TL}(\delta)$ is*

$$\text{Crossing} = \text{Two parallel lines} + \text{Two cups}$$

Proof. The endomorphism algebra of the second tensor power in $\mathbf{TL}(\delta)$ is two dimensional. This implies the general symmetric structure looks like

$$\text{Crossing} = a \cdot \text{Two parallel lines} + b \cdot \text{Two cups}$$

Define the pivoting map by the formula

$$\text{Box } f \text{ on vertical lines} \mapsto \text{Box } f \text{ on horizontal lines} = \text{Box } f \text{ on vertical lines with cups/caps}$$

Up to isotopy, the pivoting map rotates the string diagrams by 90 degrees. We can build the pivoting map out of cups and caps using composition and tensor product. Therefore, applying the pivoting map to an equation in the tensor category gives a new equation. If we apply the pivoting map to the general symmetric structure and equate coefficients, then we get $a = b$. If we square the tensor flip and take coefficients of the identity, then we get $a^2 = 1$ which implies $a = \pm 1$. Therefore, up to negation, there is at most one symmetric monoidal structure on $\mathbf{TL}(\delta)$. \square

In particular, this proves that the category of finite dimensional $\text{SL}_2(\mathbb{C})$ -representations is rigid as a symmetric monoidal category. Now let us think about braided monoidal structures on $\mathbf{TL}(\delta)$. In a symmetric monoidal category, the tensor flip behaves like a generator in the symmetric group. In a braided monoidal category, the tensor flip behaves like a generator in the braid group.

Proposition 18. *On the tensor category $\mathbf{TL}(-a^2 - 1/a^2)$, a braiding must be of the form*

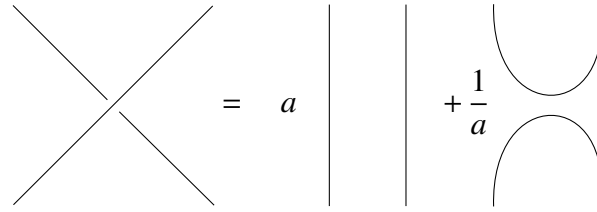

$$\text{Crossing} = a \left(\text{Two vertical lines} \right) + \frac{1}{a} \left(\text{Two cups} \right)$$

Proof. The general braiding looks like

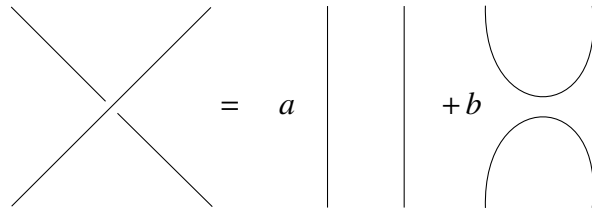

$$\text{Crossing} = a \left(\text{Two vertical lines} \right) + b \left(\text{Two cups} \right)$$

If we apply the pivot map to this equation, we get

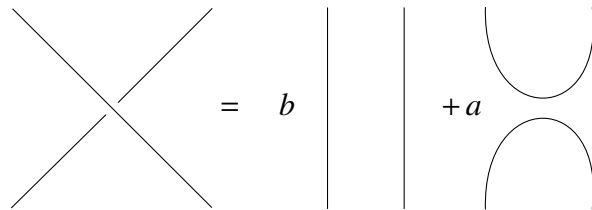

$$\text{Crossing} = b \left(\text{Two vertical lines} \right) + a \left(\text{Two cups} \right)$$

If we compose these string diagrams, we get the equations $ab = 1$ and $a^2 + b^2 = ab\delta$ which implies that $b = 1/a$ and $\delta = -a^2 - 1/a^2$. \square

When a is generic, this braided tensor category is well known as the type 1 representations of the quantum group $U_a(\mathfrak{sl}_2)$.

1.5 Semi-Normal forms

For most tensor categories of interest, the $6j$ -symbols with respect to any trivalent vertices are out of reach. If we care about explicit representations of endomorphism algebras, then we don't need to compute a full set of $6j$ -symbols.

Definition 19. Let \mathbf{X} be a semi-simple tensor category with distinguished object X . If

$\sigma \in \text{End}(X^{\otimes 2})$ then we have

The diagram shows an equality between two expressions. On the left, a trivalent vertex with inputs λ and μ and output μ is shown with a box labeled σ on the top edge. The edges are labeled a and b at the bottom. On the right, the same trivalent vertex is shown with edges labeled f and g at the bottom. The equality is expressed as $= \sum_{f,g} m_{f,g,ab}(\sigma)$.

We call the matrix $m(\sigma)$ a **semi-normal form** for σ .

Example 20. Consider the multiplicity space $\text{hom}_{\text{SL}_2(\mathbb{C})}(V_1, V_1^{\otimes 3})$. It has basis

The diagram shows two trivalent vertices with inputs $1, 1, 1$ and output 1 . The first vertex has a central label 0 , and the second vertex has a central label 2 . They are enclosed in large curly braces and separated by a comma.

To compute the semi-normal form of the tensor flip in this case, we need to choose matrix representations for each trivalent vertex:

A trivalent vertex with two top edges labeled 1 and one bottom edge labeled 0 is shown to be equal to the column vector $\begin{pmatrix} 0 \\ i \\ -i \\ 0 \end{pmatrix}$.

A trivalent vertex with one top edge labeled 0 and two top edges labeled 1 , and one bottom edge labeled 1 is shown to be equal to the matrix $\begin{pmatrix} 1 & 0 \\ 0 & 1 \end{pmatrix}$.

$$\begin{array}{c} 1 \quad 1 \\ \diagdown \quad / \\ \quad \\ | \\ 2 \end{array} = \begin{pmatrix} 1 & 0 & 0 \\ 0 & 1/2 & 0 \\ 0 & 1/2 & 0 \\ 0 & 0 & 1 \end{pmatrix}$$

$$\begin{array}{c} 2 \quad 1 \\ \diagdown \quad / \\ \quad \\ | \\ 1 \end{array} = \begin{pmatrix} 0 & 0 \\ -1 & 0 \\ 1 & 0 \\ 0 & -1 \\ 0 & 1 \\ 0 & 0 \end{pmatrix}$$

The last matrix is somewhat mysterious and we leave its computation as an exercise. From these equations, we get

$$\begin{array}{c} 1 \quad 1 \quad 1 \\ \diagdown \quad / \quad / \\ \quad \quad \\ \quad \quad 0 \\ \quad \quad / \\ \quad \quad / \\ \quad \quad / \\ | \\ 1 \end{array} = \begin{pmatrix} 0 & 0 \\ 0 & 0 \\ i & 0 \\ 0 & i \\ -i & 0 \\ 0 & -i \\ 0 & 0 \\ 0 & 0 \end{pmatrix}$$

$$\begin{array}{c} 1 \quad 1 \quad 1 \\ \diagdown \quad / \quad / \\ \quad \quad \\ \quad \quad 2 \\ \quad \quad / \\ \quad \quad / \\ \quad \quad / \\ | \\ 1 \end{array} = \begin{pmatrix} 0 & 0 \\ -1 & 0 \\ \frac{1}{2} & 0 \\ 0 & -\frac{1}{2} \\ \frac{1}{2} & 0 \\ 0 & -\frac{1}{2} \\ 0 & 1 \\ 0 & 0 \end{pmatrix}$$

These matrices are a basis for the multiplicity space $\text{hom}_{\text{SL}_2(\mathbb{C})}(V_1, V_1^{\otimes 3})$. We choose a

matrix representation for the tensor flip:

$$\begin{array}{c} | \\ \diagdown \\ \diagup \\ | \end{array} = \begin{pmatrix} 1 & 0 & 0 & 0 & 0 & 0 & 0 & 0 \\ 0 & 0 & 1 & 0 & 0 & 0 & 0 & 0 \\ 0 & 1 & 0 & 0 & 0 & 0 & 0 & 0 \\ 0 & 0 & 0 & 1 & 0 & 0 & 0 & 0 \\ 0 & 0 & 0 & 0 & 1 & 0 & 0 & 0 \\ 0 & 0 & 0 & 0 & 0 & 0 & 1 & 0 \\ 0 & 0 & 0 & 0 & 0 & 0 & 1 & 0 \\ 0 & 0 & 0 & 0 & 0 & 0 & 0 & 1 \end{pmatrix}$$

From this, we compute the semi-normal form:

$$\begin{pmatrix} 1/2 & 3i/4 \\ -i & -1/2 \end{pmatrix}.$$

Example 21. The **Iwahori-Hecke algebra**, denoted by H_m , is the algebra generated over $\mathbb{C}(a)$ by $1, g_1, \dots, g_{m-1}$ subject to the relations

$$\begin{aligned} g_i g_{i+1} g_i &= g_{i+1} g_i g_{i+1} \\ g_i g_j &= g_j g_i \quad \text{if } |i-j| \geq 2 \\ g_i^2 &= (a - a^{-1})g_i + 1. \end{aligned}$$

We define the category H which has objects the natural numbers and morphisms

$$H(m, n) = \begin{cases} H_m & m = n \\ 0 & \text{otherwise.} \end{cases}$$

The inclusion $H_m \otimes H_n \rightarrow H_{m+n}$ defined by $g_i \otimes g_j \mapsto g_i g_{m+j}$ equips H with a tensor structure. We define $\mathcal{H} \subseteq [H^{\text{op}}, \mathbf{Vec}]$ to be the idempotent completion of H . The monoidal structure on H extends to \mathcal{H} via Day convolution. Morally, the category \mathcal{H} can be described as finite dimensional type 1 representations of the quantum group $U_a(\mathfrak{gl}_\infty)$. The Grothendieck ring for \mathcal{H} has basis given by partitions and multiplication given by the Littlewood-Richardson rule. A special case of the Littlewood-Richardson rule is the Pieri rule:

$$\lambda \otimes \square = \sum_{\lambda \subset \mu \vdash n+1} \mu$$

This implies that the fusion graph for \square is Young's graph:

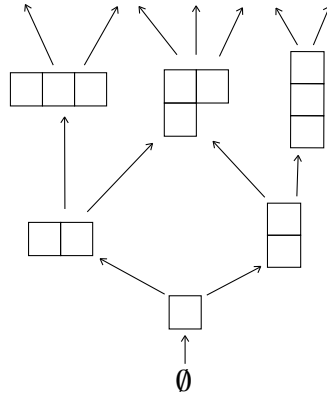

Paths in the Young graph are in bijection with standard partition fillings. It follows that the trivalent basis vectors

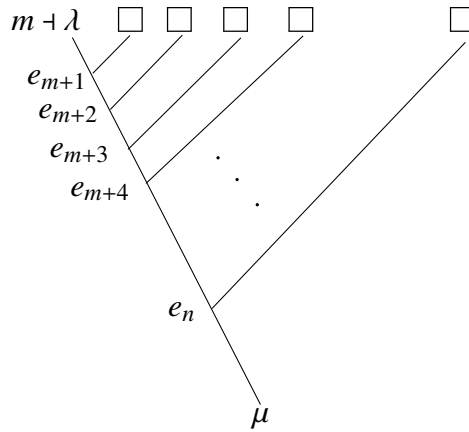

are in bijection (up to scaling) with standard skew tableaux of shape $\mu \setminus \lambda$. We abuse notation and identify these tree basis vectors with the corresponding standard skew tableaux. In [LR97], Ram and Leduc computed semi-normal forms for the Iwahori-Hecke algebras. More precisely, suppose that $\lambda \subseteq \mu \vdash n+2$ are partitions such that $\mu \setminus \lambda$ is not contained in a single row or column. Then there are exactly two partitions which satisfy $\lambda \subseteq \nu \subseteq \mu$. Call them ν and ν' . The multiplicity space $\mathcal{H}(\mu, \lambda \otimes \square \otimes \square)$ is 2-dimensional with basis

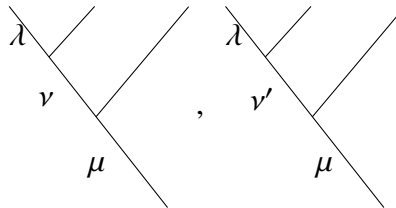

We have

$$m(g_1) = \begin{pmatrix} a^d/[d] & [d-1][d+1]/[d]^2 \\ 1 & a^{-d}/[-d] \end{pmatrix}$$

where

$$[n] = \frac{a^n - a^{-n}}{a - a^{-1}}$$

and $d = d_1 + d_2$ is the axial distance in $\mu \setminus \lambda$:

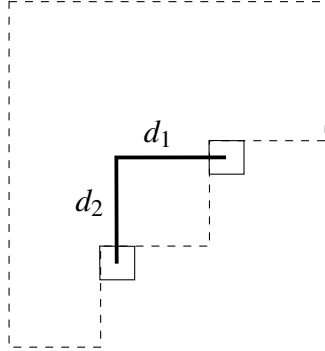

More formally, if $\mu \setminus \lambda$ contains the boxes $(a_1, b_1), (a_2, b_2)$, then the axial distance is defined by $d = |a_1 - a_2| + |b_1 - b_2|$. These formulas are quantum analogues of the well known Young semi-normal form for the representation theory of the symmetric group [JK81]. Indeed, when $a \rightarrow 1$, they recover they classical Young semi-normal formulas.

1.6 The Ribbon Argument

Suppose that \mathbf{X} is a braided tensor category and each object has a dual. Then for each simple object λ , we have

$$\left. \begin{array}{c} \lambda \\ | \\ \circlearrowleft \\ | \\ \lambda \end{array} \right| = \theta_\lambda$$

where θ_λ is a constant. If λ^* is the dual of λ , $p : \lambda \otimes \lambda^* \rightarrow \mathbb{C}$ is the pairing, $c : \mathbb{C} \rightarrow \lambda \otimes \lambda^*$ is the co-pairing and $\sigma : \lambda \otimes \lambda \rightarrow \lambda \otimes \lambda$ is the braiding, then

$$\begin{array}{c} \lambda \\ | \\ \text{---} \\ | \\ \lambda \end{array} = (\text{id} \otimes p)(\sigma \otimes \text{id})(\text{id} \otimes c)$$

The constants θ_λ are always known explicitly in practice. For example, in the quantum group case, we have $\theta_\lambda = a^{-(\lambda, \lambda + 2\rho)}$ where ρ is the half sum of positive roots. We have the following beautiful equation:

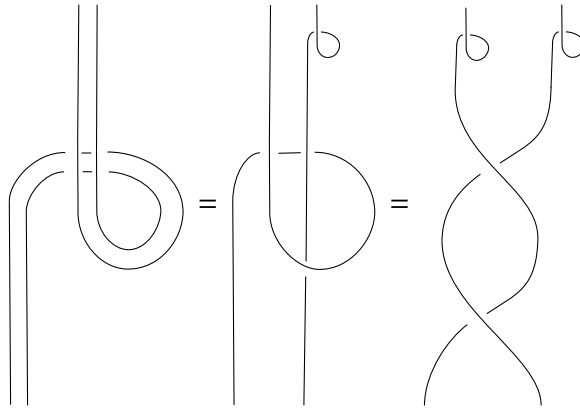

This implies that

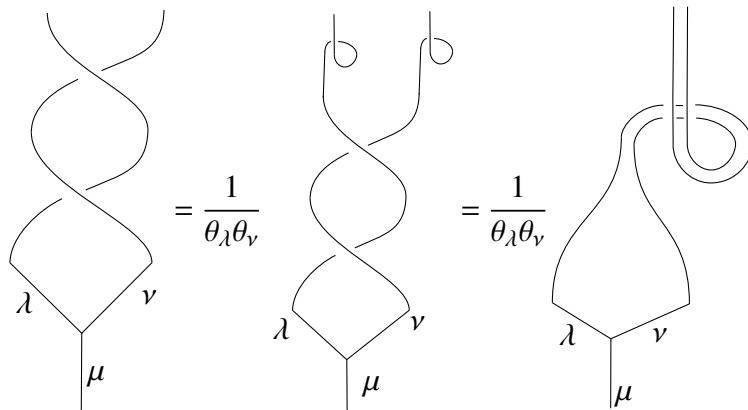

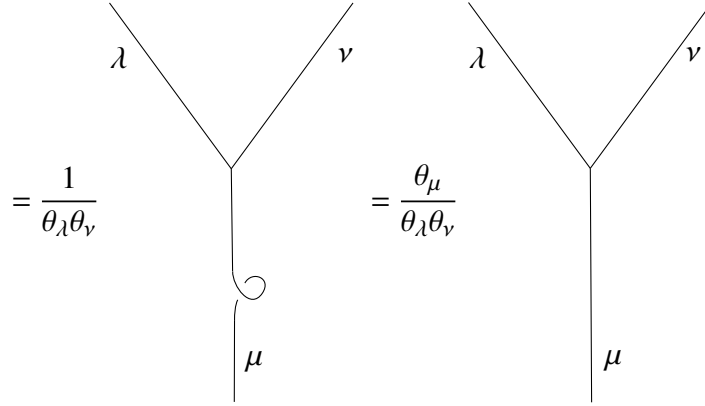

In words, the trivalent basis vectors are eigenvectors for the double braid and we can explicitly compute the eigenvalues. This is called the ribbon argument and will be important for motivation in Chapter 4. There is one subtle point worth mentioning. Although we can perform the ribbon argument in any braided tensor category with duals, there are several slight variants of the argument which might produce different scalars θ'_λ . The root of this issue is the distinction between left and right traces, and it goes away when left and right traces are equal:

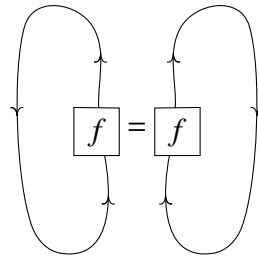

For this reason, a braided tensor category with duals where left and right traces agree is called a **ribbon tensor category**.

CHAPTER 2

Semi-Normal Forms and 6j Symbols

A semi-simple tensor category is determined up to equivalence by its Grothendieck ring and its $6j$ -symbols with respect to a set of tree basis vectors. The $6j$ -symbols are the coordinate representation of the associator. Despite their importance, we only know explicit formulas for $6j$ -symbols in a few special cases. In the $SL_2(\mathbb{C})$ and $U_a(\mathfrak{sl}_2)$ cases, explicit formulas for the $6j$ -symbols are computed in [CFS95]. As far as the author is aware, the only other case where explicit $6j$ -symbols are known is G -graded vector spaces for G a finite group. In this case, associators are cohomology classes in $H^3(G, \mathbb{C}^\times)$.

In this chapter, we compute a large number of $6j$ -symbols inside the tensor category \mathcal{H} consisting of polynomial type 1 representations of $U_a(\mathfrak{gl}_\infty)$. This category was defined in Example 21.

Suppose that $\lambda \subseteq \mu \vdash n+2$ are partitions such that $\mu \setminus \lambda$ is not contained in a single row or column. There are exactly two partitions which satisfy $\lambda \subseteq \nu \subseteq \mu$. Call them ν and ν' . The multiplicity space $\mathcal{H}(\lambda \otimes \square \otimes \square, \mu)$ is 2-dimensional and we have the following two bases:

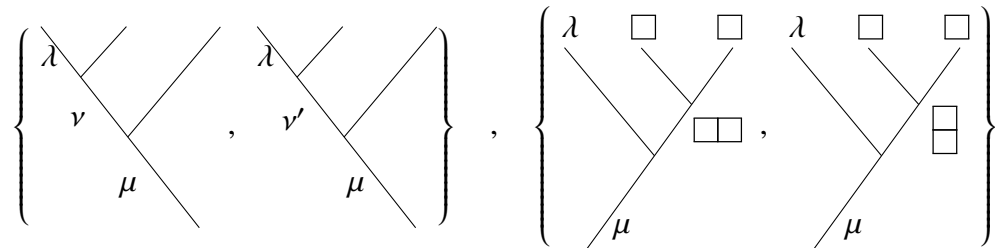

The $6j$ -symbols are the entries of the matrix relating these two bases.

Proposition 22. *Let $\lambda \subseteq \mu$ be partitions such that $\mu \setminus \lambda$ has two boxes not contained in a single row or column. Then*

$$(j_{\mu}^{\lambda, \square, \square})^{-1} = \begin{pmatrix} \frac{a^{2d+2}-1}{a(a^{2d}-1)} & \frac{a^2-a^{2d}}{a(a^{2d}-1)} \\ 1 & 1 \end{pmatrix}$$

where d is the axial distance in the skew partition $\mu \setminus \lambda$.

Proof. Identify $\square\square$ with projection onto the corresponding isotypic component in H_2 . We have

$$\square\square = \frac{1}{1+a^2}(e + ag_1).$$

where g_1 is the simple reflection. This formula generalizes the invariant symmetrizer from the symmetric group. It follows that

$$m(\square\square) = \frac{1}{1+a^2}(1 + am(g_1)) = \begin{pmatrix} \frac{a^{2d+2}-1}{(a^2+1)(a^{2d}-1)} & \frac{(a^{2d}-a^2)(a^{2d+2}-1)}{(a^3+a)(a^{2d}-1)^2} \\ \frac{a}{a^2+1} & \frac{a^{2d}-a^2}{(a^2+1)(a^{2d}-1)} \end{pmatrix}$$

where m , defined in section 1.5, takes an algebra element to its semi-normal form matrix. On the left basis, $\square\square$ acts via $m(\square\square)$. On the right basis, $\square\square$ projects onto the first basis vector and kills the second basis vector. Therefore the basis vectors on the right are the 0 and 1 eigenvectors respectively for the matrix $m(\square\square)$. Computing these eigenvectors in the left basis proves the proposition. \square

If we take the limit as $a \rightarrow 1$ then we get the matrix

$$\begin{pmatrix} 1+1/d & -1+1/d \\ 1 & 1 \end{pmatrix}.$$

This gives the $6j$ -symbols in the category of polynomial $GL(\infty)$ -representations. More generally, the same trick will work whenever $X \otimes X$ is multiplicity free and $\dim \mathcal{C}(\mu, \lambda \otimes X \otimes X)$ equals the number of isotypic components in $X \otimes X$. Despite the simple proof, Proposition 22 shows us that we can extract $6j$ -symbols from semi-normal forms. Therefore, computing semi-normal forms is as hard as computing $6j$ -symbols.

CHAPTER 3

Minimal Model for the Quantum Symmetric Algebra

Let \mathcal{S} be the category of polynomial $\mathrm{GL}(\infty)$ -representations studied by Sam and Snowden in [SS16]. This category contains the algebra $\mathrm{Sym} = \mathbb{C}[x_1, x_2, \dots]$ which is Morita equivalent to **FI**, the category of finite sets with injections. A proof can be found in [SS17]. In Section 3 of [SS16], Sam and Snowden prove that Sym is Morita equivalent to **HS**, the category whose objects are partitions and whose morphisms are defined by

$$\mathbf{HS}(\lambda, \mu) = \begin{cases} \mathbb{C}\{\mu \setminus \lambda\} & \lambda \subseteq \mu, \mu \setminus \lambda \in \mathbf{HS} \\ 0 & \text{otherwise} \end{cases}$$

Composition is defined as follows: Assume that $\mu \setminus \lambda$ and $\nu \setminus \mu$ are horizontal strips. If $\nu \setminus \lambda$ is a horizontal strip, then

$$(\nu \setminus \mu)(\mu \setminus \lambda) = \nu \setminus \lambda.$$

If $\nu \setminus \lambda$ is not a horizontal strip, then the composition is zero. Now let \mathcal{H} be the category of polynomial type 1 representations of $U_a(\mathfrak{gl}_\infty)$ defined in Example 21. Inside \mathcal{H} , we have the quantum symmetric algebra QSym . In this chapter, we prove the following:

Theorem 23. *The quantum symmetric algebra QSym is Morita equivalent to **HS** for generic a .*

Theorem 23 implies that many of the results in [SS16] which hold for Sym are also true for QSym .

3.1 Morita Theory

In this section, we prove a very mild generalization of classical Morita theory. In classical Morita theory, we replace an object with its presentation with respect to a single projective.

We are going to replace an object with its presentation with respect to a family of projectives. For the remainder of this section, \mathbf{X} is an abelian category enriched over \mathbf{Vec}_k , closed under colimits, \mathbf{D} is a category enriched over \mathbf{Vec}_k and $D : \mathbf{D}^{\text{op}} \rightarrow \mathbf{X}$ is a functor.

Theorem 24. *If \mathbf{X} has enough projectives, then \mathbf{X} is equivalent to the category of representations of \mathbf{D} where \mathbf{D}^{op} is a full subcategory of \mathbf{X} whose objects are compact, projective and generate \mathbf{X} .*

We can prove this in a very clean way using coends. They can be motivated as follows: Suppose that A is a k -algebra, M is a left A -module and N is a right A -module. Then we can form the tensor product $M \otimes_A N$ which is a vector space. It is built by taking the tensor product $M \otimes_k N$ and quotienting by the relations

$$am \otimes n = m \otimes na.$$

We can generalize the second step in the following way. Suppose that $F : \mathbf{D} \otimes_k \mathbf{D}^{\text{op}} \rightarrow \mathbf{Vec}_k$ is a bifunctor. Then we can form the vector space

$$\int^{d \in \mathbf{D}} F = \bigoplus_{d \in \mathbf{D}} F(d, d) / fv = vf \quad v \in F(d, d'), f : d' \rightarrow d.$$

This vector space is called the **coend** of F . We can use coends to generalize tensor products from modules to functors. Suppose that $F : \mathbf{D} \rightarrow \mathbf{Vec}$ and $G : \mathbf{D}^{\text{op}} \rightarrow \mathbf{Vec}$ are functors. Then we define

$$F \otimes_{\mathbf{D}} G = \int^{d \in \mathbf{D}} F(d) \otimes G(d).$$

A clear exposition of the theory of coends can be found in [Rie14]. Let \mathbf{D} a category enriched over \mathbf{Vec} . Suppose that we have a functor $D : \mathbf{D}^{\text{op}} \rightarrow \mathbf{X}$. Then we get a functor

$$\begin{aligned} \mathbf{X} &\rightarrow [\mathbf{D}, \mathbf{Vec}] \\ X &\mapsto \mathbf{X}(D(-), X) \end{aligned}$$

This functor has a left adjoint given by

$$\begin{aligned} [\mathbf{D}, \mathbf{Vec}] &\rightarrow \mathbf{X} \\ V &\mapsto V \otimes_{\mathbf{D}} D = \int^d V_d \otimes D^d \end{aligned}$$

The following computation demonstrates why these functors are adjoint:

$$\begin{aligned}
\mathbf{X}(V \otimes_{\mathbf{D}} D, X) &= \mathbf{X}\left(\int^d V_d \otimes D^d, X\right) \\
&= \int_d \mathbf{X}(V_d \otimes D^d, X) \\
&= \int_d \text{hom}(V_d, \mathbf{X}(D^d, X)) \\
&= [\mathbf{D}, \mathbf{Vec}](V, \mathbf{X}(D(-), X))
\end{aligned}$$

Definition 25. We call $X \in \mathbf{X}$ a **compact** object if $\mathbf{X}(X, -)$ commutes with filtered colimits.

Proposition 26. *Assume that D is fully faithful and each $D(d)$ is projective and compact. Then $[\mathbf{D}, \mathbf{Vec}] \rightarrow \mathbf{X}$ is fully faithful.*

Proof. We need to prove that the unit

$$V \rightarrow \mathbf{X}(D(-), V \otimes_{\mathbf{D}} D)$$

is an isomorphism. It suffices to prove this pointwise, so we need to prove that the linear map

$$V(d) \rightarrow \mathbf{X}(D(d), V \otimes_{\mathbf{D}} D)$$

is an isomorphism. Since $D(d)$ is projective and compact, it follows that $\mathbf{X}(D(d), -)$ commutes with all colimits. Therefore

$$\begin{aligned}
\mathbf{X}\left(D(d), \int^x V(x) \otimes D(x)\right) &= \int^x V(x) \otimes \mathbf{X}(D(d), D(x)) \\
&= \int^x V(x) \otimes \mathbf{D}(x, d) \\
&= V(d)
\end{aligned}$$

The second equality is true because \mathbf{D} is fully faithful. □

Proposition 27. *In addition to the hypotheses of proposition 26, assume that every $X \in \mathbf{X}$ admits an epimorphism $\bigoplus_i D(d_i) \rightarrow X$ for some family $\{d_i\}$. Then $[\mathbf{D}, \mathbf{Vec}] \rightarrow \mathbf{X}$ is essentially surjective.*

Proof. By assumption, it follows that for every $X \in \mathbf{X}$, the counit

$$\mathbf{X}(D(-), X) \otimes_{\mathbf{D}} D \rightarrow X$$

is an epimorphism. Then we have an exact sequence

$$0 \rightarrow K \rightarrow \mathbf{X}(D(-), X) \otimes_{\mathbf{D}} D \rightarrow X \rightarrow 0$$

This gives us an exact sequence

$$\mathbf{X}(D(-), K) \otimes_{\mathbf{D}} D \rightarrow \mathbf{X}(D(-), X) \otimes_{\mathbf{D}} D \rightarrow X \rightarrow 0$$

Since $-\otimes_{\mathbf{D}} D$ is fully faithful, we can write the first map as $f \otimes_{\mathbf{D}} D$ for some map $f : \mathbf{X}(D(-), K) \rightarrow \mathbf{X}(D(-), X)$. Since $-\otimes_{\mathbf{D}} D$ is right exact, it follows that $X = \text{coker } f \otimes_{\mathbf{D}} D$. This proves essential surjectivity. \square

Proof of theorem 24. Let \mathbf{D}^{op} be a full subcategory of \mathbf{X} whose objects are compact, projective and generate \mathbf{X} . Let $D : \mathbf{D}^{\text{op}} \rightarrow \mathbf{X}$ be the embedding. By proposition, 26, the functor $-\otimes_{\mathbf{D}} D : [\mathbf{D}, \mathbf{Vec}] \rightarrow \mathbf{X}$ is fully faithful. By Proposition 27, the functor is essentially surjective. \square

Definition 28. If \mathbf{X} is an abelian category with enough compact projectives, define $M(\mathbf{X})$ to be the opposite of the full subcategory with objects the indecomposable compact projectives. We call $M(\mathbf{X})$ the **minimal model** for \mathbf{X} . By theorem 24, the functor category $[M(\mathbf{X}), \mathbf{Vec}]$ is equivalent to \mathbf{X} .

3.2 Modules over Tensor Algebras

In this section, we work inside a fixed semi-simple tensor category \mathcal{C} . We use Morita theory to study the category of modules over an algebra internal to \mathcal{C} . Choose a distinguished simple object $X \in \mathcal{C}$. Define

$$T = \bigoplus_{n \geq 0} X^{\otimes n}$$

This is the tensor algebra generated by X . Define $\text{Rep}(T)$ to be the category of right modules over T internal to \mathcal{C} . The forgetful functor $F : \text{Rep}(T) \rightarrow \mathcal{C}$ has left adjoint $L : \mathcal{C} \rightarrow \text{Rep}(T)$ defined by $V \mapsto V \otimes T$. Since the right adjoint F is exact, it follows that L preserves projectives. Define

$$T^+ = \bigoplus_{n \geq 1} X^{\otimes n}$$

Lemma 29. *If $V \in \mathcal{C}$ is irreducible, then $V \otimes T$ is an indecomposable projective in $\text{Rep}(T)$.*

Proof. Since $V \otimes T = L(V)$, the module is projective. Suppose that $V \otimes T = A \oplus B$ as T -modules. When we tensor with T/T^+ , we get

$$V = A/AT^+ \oplus B/BT^+$$

in \mathcal{C} . Since V is irreducible in \mathcal{C} , we can assume without loss of generality that $A/AT^+ = 0$. Suppose that $A \neq 0$. Choose $0 \neq Y \subseteq A \subseteq V \otimes T$ irreducible in \mathcal{C} . This implies that

$$Y \subseteq \bigoplus_{n=0}^N V \otimes X^{\otimes n}$$

for some large N . Since $A = A(T^+)^{N+1}$, it follows that

$$Y \subseteq A(T^+)^{N+1} \subseteq \bigoplus_{n \geq N+1} V \otimes X^{\otimes n}.$$

This implies that $Y = 0$, which is a contradiction. Therefore we must have $A = 0$. □

Proposition 30. *Let G be the fusion graph for X considered as a category where the objects are vertices and the morphisms are paths. Then $\text{Rep}(T)$ is Morita equivalent to $[G, \mathbf{Vec}]$.*

Proof. The indecomposable compact projectives $\lambda \otimes T$, where λ is an irreducible in \mathcal{C} , generate $\text{Rep}(T)$. Using the adjunction $(L, F) : \text{Rep}(T) \rightarrow \mathcal{C}$, we have

$$\text{hom}_T(\mu \otimes T, \lambda \otimes T) = \mathcal{C}(\mu, \lambda \otimes T).$$

The right hand side has a basis consisting of vectors of the form

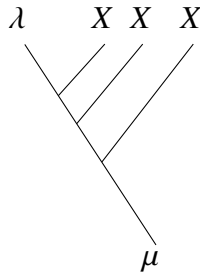

which is exactly a path in the fusion graph for X from λ to μ . Post composing with the

corresponding morphism in $\text{hom}_T(\mu \otimes T, \lambda \otimes T)$ is the map

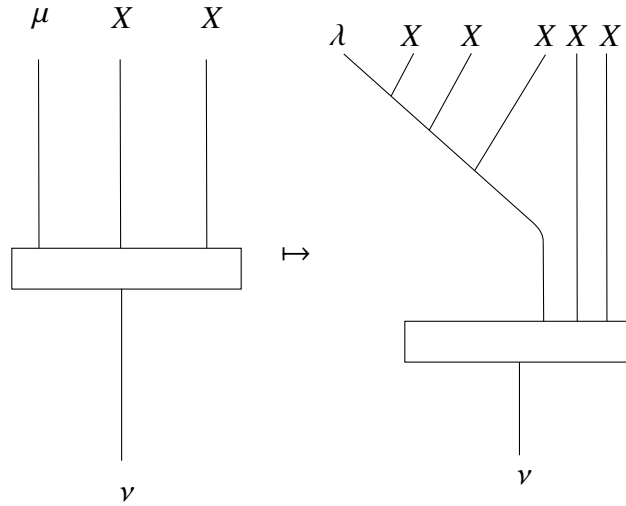

This implies that composition of basis vectors is exactly concatenation of paths in the fusion graph for X . This completes the proof. \square

Example 31. Let $\mathcal{C} = \mathcal{H}$, which was defined in Example 21, and let $X = \square$. The fusion graph for X has objects partitions and the edges $G(\lambda, \mu)$ are the standard skew tableaux of shape $\mu \setminus \lambda$.

3.3 Modules over the quantum symmetric algebra

In this section, we work inside the category \mathcal{H} defined in Example 21. Define $T = \bigoplus_{n \geq 0} \square^{\otimes n}$. Consider the submodule I of T spanned by all maps

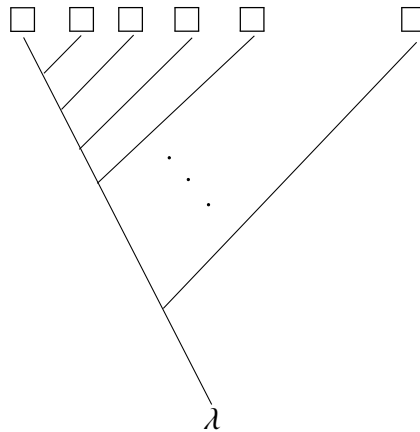

where λ is a partition with two or more rows. The grading on the Grothendieck ring implies that I is a 2-sided ideal in T , so we can form the quotient algebra $S = T/I$. We have

$$S = \emptyset \oplus \square \oplus \square\square \oplus \square\square\square \oplus \dots$$

Define $\text{Rep}(S)$ to be category of right modules over S internal to the category \mathcal{H} . Just like the tensor algebra, every projective S -module is free and the indecomposable projectives are of the form $\lambda \otimes S$ where λ is a partition. Define F to be the fusion graph for \square inside \mathcal{H} interpreted as a category. Define M to be the category whose objects are partitions and whose morphisms are defined by

$$M(\lambda, \mu) = \text{hom}_S(\mu \otimes S, \lambda \otimes S).$$

Then we have the functor $Q = - \otimes_T S : F \rightarrow M$. By definition, this functor is the identity on objects. Since all the projectives involved are free, it follows that Q is full. We can describe Q more concretely as follows. Each hom space in F is a skew representation of some Iwahori-Hecke algebra. We have:

Lemma 32. *On morphisms, Q projects onto the Hecke algebra invariants.*

Proof. Recall that given a vector $f \in F(\lambda, \mu)$, post composition by the induced map $\text{hom}_T(\mu \otimes T, \lambda \otimes T)$ is given by

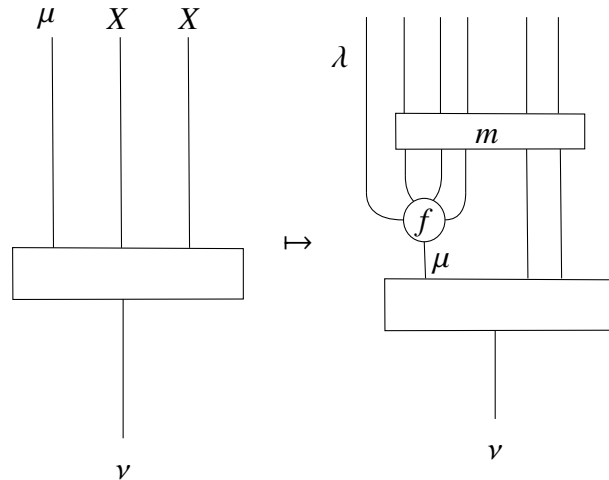

More precisely, the map $f : \mu \rightarrow \lambda \otimes X^{\otimes n}$ induces a map $\mu \otimes T \rightarrow \lambda \otimes T$ defined by

$$g : \mu \otimes T \xrightarrow{f \otimes 1} \lambda \otimes X^{\otimes n} \otimes T \xrightarrow{1 \otimes m} \lambda \otimes T$$

where m is the multiplication map. The diagram depicts post composing a map $\nu \rightarrow \mu \otimes T$

with g . By Yoneda's lemma, this determines g . If we tensor along the projection $p : T \rightarrow S$ we have

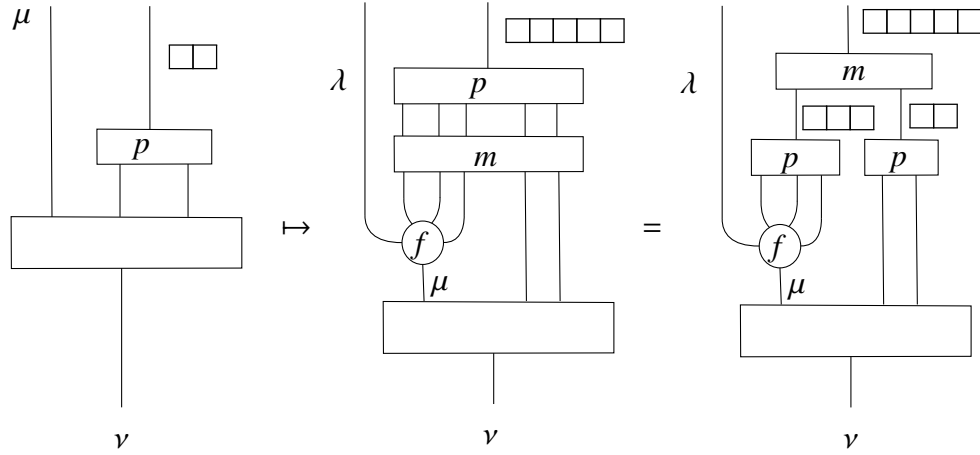

The second equality is true because p is an algebra homomorphism, so it commutes with multiplication. □

Proposition 33. *Suppose that $\lambda \subseteq \mu$ are partitions. Then $\mathcal{H}(\mu, \lambda \otimes \square^{\otimes n})$ has Hecke algebra invariants if and only if $\mu \setminus \lambda$ is a horizontal strip. In this case, the invariants are 1-dimensional and any skew tableaux projects onto a nonzero invariant.*

Proof. The invariants in $\mathcal{H}(\mu, \lambda \otimes \square^{\otimes n})$ are the same as maps

$$\mu \rightarrow \lambda \otimes \underbrace{\square \square \square \square}_n$$

By Pieri's rule, $\mathcal{H}(\mu, \lambda \otimes \square^{\otimes n})$ has invariants if and only if $\mu \setminus \lambda$ is a horizontal strip. Suppose that $\mu \setminus \lambda$ is a horizontal strip and P is a skew tableaux of shape $\mu \setminus \lambda$. Then from the semi-normal form, we know that P generates $\mathcal{H}(\mu, \lambda \otimes \square^{\otimes n})$. This implies that $\mathcal{H}(\mu, \lambda \otimes \square^{\otimes n})$ has a 1-dimensional space of invariants and P projects onto a nonzero invariant. □

Proof of Theorem 23. The minimal model for S is M . From Lemma 32, $Q : F \rightarrow M$ is a full functor which is projection onto the Hecke algebra invariants. From Proposition 33, we have

$$M(\mu, \lambda) = F(\mu, \lambda)^{H_n} = \mathcal{H}(\mu, \lambda \otimes \square)^{H_n} = \mathbf{HS}(\mu, \lambda).$$

□

CHAPTER 4

A Sufficient Condition for the Braid Group to Surject onto Endomorphism Algebras

Let \mathcal{C} be a semi-simple braided tensor category defined over a characteristic zero field k . Choose a distinguished object $X \in \mathcal{C}$. One of the central problems in quantum algebra is deciding if the map $k[B_n] \rightarrow \text{End}(X^{\otimes n})$ is surjective. In [LZ06], Zhang and Lehrer define strongly multiplicity free representations, which gives a sufficient condition in the case when \mathcal{C} is finite dimensional representations of a Lie algebra or quantum group. Moreover, they classify all strongly multiplicity free representations. In this chapter, we give a new condition which implies that each map $k[B_n] \rightarrow \text{End}(X^{\otimes n})$ is surjective.

4.1 The Affine Braid Group

Definition 34. Let \mathcal{C} be a semi-simple braided tensor category and $X \in \mathcal{C}$ a distinguished object. Consider the functor $T_X^n : \mathcal{C} \rightarrow \mathcal{C}$ defined by $a \mapsto a \otimes X^{\otimes n}$. Let $\sigma_1, \dots, \sigma_{n-1}$ be the standard generators of the braid group B_n . Then we have a homomorphism

$$AB_n = \langle \sigma_1^2, \sigma_2, \dots, \sigma_n \rangle \rightarrow \text{End}(T_X^n)$$

The braid σ_1 does not act because it has domain $a \otimes X$ and codomain $X \otimes a$. We call AB_n the **affine braid group**.

Geometrically, AB_n is like B_n but the braids are allowed to wrap around a *pole* on the

left:

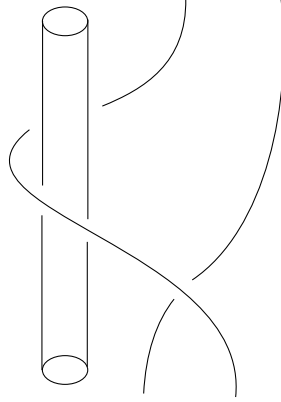

More precisely, AB_n is the fundamental group of configurations of n points in $\mathbb{C} \setminus \{0\}$.

Suppose that \mathcal{C} is a braided tensor category and $\lambda \otimes X$ is multiplicity free. Since the double braid must preserve isotypic components, the trivalent vertices are eigenvectors for the double braid. This allows us to define $\theta_\mu / \theta_\lambda \theta_X$ from section 1.6 in a category which may not have duals.

Definition 35. Suppose that \mathcal{C} is a braided tensor category. We call $X \in \mathcal{C}$ **weakly multiplicity free** if for each simple object $\lambda \in \mathcal{C}$, the object $\lambda \otimes X$ is multiplicity free and $\theta_\mu \neq \theta_\nu$ for distinct edges $\lambda \rightarrow \mu$ and $\lambda \rightarrow \nu$ in the fusion graph of X . This definition appears in [LZ06].

Lemma 36. *Suppose that X is weakly multiplicity free. Then the image of $k[AB_n] \rightarrow \text{End}(\lambda \otimes X^{\otimes n})$ contains every diagonal matrix with respect to our chosen trivalent vertices.*

Proof. Fix a weakly multiplicity free object $X \in \mathcal{C}$ and choose a set of trivalent vertices in \mathcal{C} . The operator σ_1^2 acts on

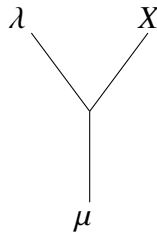

via the scalar $c_{\lambda \rightarrow \mu} = \theta_\mu / \theta_\lambda \theta_X$. Define

$$P_{\lambda \rightarrow \mu}^X = \prod_{\lambda \rightarrow \nu \neq \mu} \frac{\sigma_1^2 - c_{\lambda \rightarrow \nu}}{c_{\lambda \rightarrow \mu} - c_{\lambda \rightarrow \nu}} \in k[AB_1]$$

This operator is the projection onto μ inside $\lambda \otimes X$. It is well-defined because X is weakly

multiplicity free. Since σ_1^2 is natural in the leftmost strand, we have

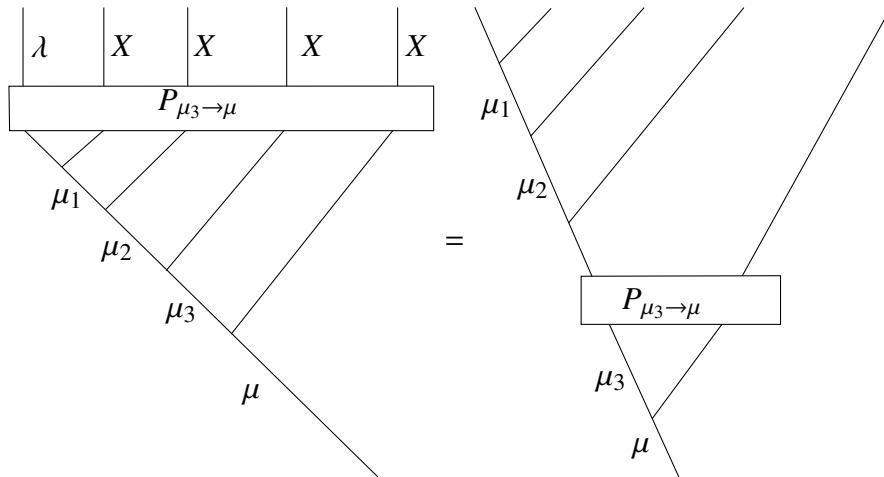

It follows that

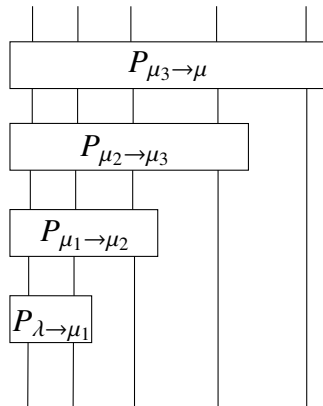

is a diagonal rank 1 projection living in the affine braid group with eigenvector

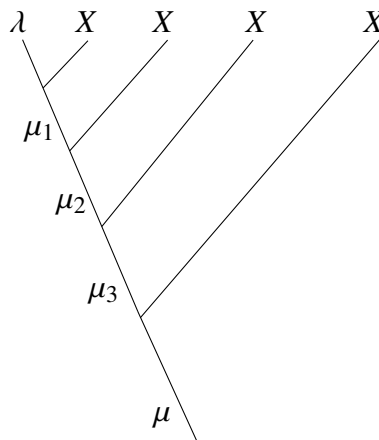

This completes the proof. □

4.2 The Sufficient Condition

Definition 37. Let \mathcal{C} be a semi-simple tensor category and fix an object $X \in \mathcal{C}$. We say that the fusion graph of X is **discretely simply connected** if for any simple objects $\lambda, \mu \in \mathcal{C}$ and any paths P, Q from λ to μ , we can transform P to Q using a sequence of moves of the form:

$$\lambda \rightarrow \cdots \rightarrow v_{i-1} \rightarrow v_i \rightarrow v_{i+1} \rightarrow \cdots \rightarrow \mu \quad \mapsto \quad \lambda \rightarrow \cdots \rightarrow v_{i-1} \rightarrow \chi \rightarrow v_{i+1} \rightarrow \cdots \rightarrow \mu$$

This is a combinatorial condition that we can check using the fusion ring of \mathcal{C} . It is a fun combinatorial exercise to check that the fusion graph of \square in the category of polynomial $\mathrm{GL}(\infty)$ -representations is discretely simply connected.

Theorem 38. *Let \mathcal{C} be a braided tensor category and $X \in \mathcal{C}$ a weakly multiplicity free object. Suppose the fusion graph of X is discretely simply connected and for each simple object λ , the map $k[AB_2] \rightarrow \mathrm{End}(\lambda \otimes X^{\otimes 2})$ is surjective. Then for each simple object μ and all n , the map $k[AB_n] \rightarrow \mathrm{End}(\mu \otimes X^{\otimes n})$ is surjective.*

Proof. Since the fusion graph for X is discretely simply connected, we can decompose an arbitrary matrix unit into a product of E_{PQ} 's where P and Q differ at a single vertex. Therefore, to prove that $k[AB_n] \rightarrow \mathrm{End}(\mu \otimes X^{\otimes n})$ is surjective, we need to prove that each matrix unit E_{PQ} , where P and Q differ at a single vertex, is in the image. Since each map $k[AB_2] \rightarrow \mathrm{End}(\lambda \otimes X^{\otimes 2})$ is surjective and the affine braid group action is natural in the first strand, the image of $k[AB_n] \rightarrow \mathrm{End}(\mu \otimes X^{\otimes n})$ contains a term with E_{PQ} as a summand. By Lemma 36, the image contains E_{PQ} after we left and right multiply by the correct diagonal matrices. \square

Lemma 39. *Let \mathbf{X} be the the category of polynomial type 1 $U_a(\mathfrak{gl}_\infty)$ -representations defined in Chapter 1 and $X = \square$. If λ is a partition, then $k[AB_2] \rightarrow \mathrm{End}(\lambda \otimes X^{\otimes 2})$ is surjective.*

Proof. Since X is weakly multiplicity free, by Lemma 36, the image contains all the irreducible projections. Therefore, to prove that $k[AB_2] \rightarrow \mathrm{End}(\lambda \otimes X^{\otimes 2})$ is surjective, we need to prove that $k[AB_2]$ acts irreducibly on each multiplicity space $\mathbf{X}(\mu, \lambda \otimes X^{\otimes 2})$. In \mathbf{X} , the multiplicity space $\mathbf{X}(\mu, \lambda \otimes X^{\otimes 2})$ has dimension ≤ 2 . If the dimension is 1, there is nothing to prove. Suppose that $\dim \mathbf{X}(\mu, \lambda \otimes X^{\otimes 2}) = 2$. Since σ_1^2 acts diagonally with distinct eigenvalues on the trivalent vertex basis and σ_2 acts via Young's semi-normal form which has no zero entries, surjectivity follows. \square

Example 40. Let \mathbf{X} be the category of polynomial type 1 $U_a(\mathfrak{gl}_\infty)$ -representations defined in Chapter 1. Let $X = \square$ be the first fundamental representation. In [LZ06], Lehrer and

Zhang prove that X is weakly multiplicity free. The surjectivity of $AB_2 \rightarrow \text{End}(\lambda \otimes X^{\otimes 2})$ was proved in Lemma 39. Let S, T be standard tableaux of shape λ . Then we can transform S to T by repeatedly swapping entries that are not in the same row or column. It follows that the fusion graph of X is discretely simply connected. Therefore, by Theorem 38, the affine braid group acts irreducibly on the skew partition representations. This result was first proved by Ram in [Ram03].

CHAPTER 5

Noetherianity and Rooted Trees

Let \mathbf{C} be a category and \mathbf{Vec} the category of vector spaces over a field k with arbitrary characteristic. Write $\text{Rep}(\mathbf{C})$ for the category of functors $\mathbf{C} \rightarrow \mathbf{Vec}$. Such functors are called **representations** of \mathbf{C} . Let \mathbf{T} be the category whose objects are rooted trees and morphisms are order embeddings preserving the root. We define this category more precisely in section 5.3. In this chapter we prove

Theorem 41. *Finitely generated \mathbf{T} -representations are Noetherian.*

Theorem 41 is proved using Gröbner categories, first defined by Richter in [Ric86], and further developed by Sam and Snowden in [SS17]. Gröbner categories reduce Noetherianity questions to combinatorial questions. In all examples that have been done so far, the combinatorial questions reduce to Higman’s Lemma, or some variant. For the category \mathbf{T} , the combinatorial question reduces to Kruskal’s tree Theorem.

5.1 Motivation and previous work

Theorem 41 is a generalization of Theorem 42, which was proved independently by Church, Ellenberg and Farb in [CEF15] and by Snowden in [Sno13]. Indeed, the full subcategory of \mathbf{T} with objects height one trees is \mathbf{FI} .

Theorem 42. *Let \mathbf{FI} be the category of finite sets with injections. Then finitely generated \mathbf{FI} -representations over a field of characteristic 0 are Noetherian.*

Theorem 42 has the following Corollary, due to Church, Ellenberg and Farb in [CEF15]:

Corollary 43. *Let M be a manifold and S a finite set. Then $S \mapsto C_S(M) = \{\text{injections } S \rightarrow M\}$ is a functor from \mathbf{FI}^{op} into the category of manifolds, and $S \mapsto H^d(C_S(M), \mathbb{Q})$ is a finitely generated \mathbf{FI} -representation.*

We hope that Corollary 43 convinces the reader that Theorems 41 and 42 are interesting. Motivated by Theorem 42, Sam and Snowden developed the theory of Gröbner categories in [SS17]. They proved

Theorem 44. *Let \mathbf{C} be quasi-Gröbner category. Then every finitely generated \mathbf{C} -representation is Noetherian.*

Sam and Snowden also proved that the categories $\mathbf{FI}_d, \mathbf{FS}^{\text{op}}, \mathbf{VA}, \mathbf{FI}_G, \mathbf{FS}_G^{\text{op}}$ are quasi-Gröbner. In all of these examples, the objects are parameterized by the natural numbers. The category \mathbf{T} may be the first known example of a quasi-Gröbner category whose objects do not have a natural bijection with \mathbb{N}^p .

5.2 Open problems

As far as the author is aware, the following questions are open:

1. Are there any interesting spaces which are acted upon by tree automorphism groups? If we could find non trivial functors from \mathbf{T}^{op} into the category of spaces, then Theorem 41 might imply results like Corollary 43.
2. If V is a finitely generated \mathbf{T} -representation, what can one say about the function $T \mapsto \dim V_T$? If \mathbf{C} is a quasi-Gröbner category, then it is reasonable to expect that the Hilbert series of finitely generated \mathbf{C} -representations will be nice. For example, finitely generated \mathbf{FI} -representations have rational Hilbert series.
3. Kruskal's tree Theorem is an important part of the graph minor Theorem. The category \mathbf{T} is quasi-Gröbner because of Kruskal's tree Theorem. Is there any category that is quasi-Gröbner because of the graph minor Theorem?

5.3 Rooted Trees

In this section, we explain the terms and notation used throughout the chapter. A **tree** is a connected finite graph with no loops. A **rooted tree** is a tree equipped with a root vertex. In a rooted tree, we orient every edge towards the root vertex. When drawing rooted trees,

the root vertex is at the bottom. Here is an example:

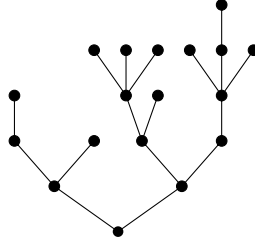

If v is a vertex, write $\text{in}(v)$ for the set of incoming edges. When we draw a picture of a rooted tree, we implicitly put an ordering on $\text{in}(v)$ for each vertex v . A **planar rooted tree** is a rooted tree equipped with a total ordering on $\text{in}(v)$ for each vertex v . Given a rooted tree T we build a partially ordered set as follows: The elements are vertices and given vertices v, w we say that $v \leq w$ if there is a downward path from v to w . We call this order the **tree order** on the vertices of T . The root is larger than all other vertices in the tree order. Let T be a planar rooted tree. We totally order the vertices using a clockwise depth-first tree walk. This total ordering is called the **depth-first ordering** on the vertices and is denoted by \triangleleft . A map of partially ordered sets $f : P \rightarrow Q$ is called an **order embedding** when $f(x) \leq f(y)$ if and only if $x \leq y$. When we say order embedding, we mean with respect to the tree order. We define the following categories:

$$\mathbf{FT} = \left\{ \begin{array}{l} \text{Objects are rooted trees and morphisms are or-} \\ \text{der embeddings} \end{array} \right\}$$

$$\mathbf{FPT} = \left\{ \begin{array}{l} \text{Objects are planar rooted trees and morphisms} \\ \text{are order embeddings which also preserving the} \\ \text{depth-first ordering on vertices} \end{array} \right\}$$

$$\mathbf{T} = \left\{ \begin{array}{l} \text{Objects are rooted trees and morphisms are or-} \\ \text{der embeddings preserving the root} \end{array} \right\}$$

$$\mathbf{PT} = \left\{ \begin{array}{l} \text{Objects are planar rooted trees and morphisms} \\ \text{are order embeddings that preserve the root and} \\ \text{the depth-first ordering on vertices} \end{array} \right\}$$

The categories \mathbf{T} and \mathbf{PT} are our main focus, but for many of the proofs, it is useful to work in \mathbf{FT} and \mathbf{FPT} . Since the morphism are order embeddings, they are injective on vertices. We can now state our main theorem, from which Theorem 41 follows. First, let us recall

the definition of a Gröbner category from [SS17].

Definition 45. A **quasi-order** is a binary relation that is reflexive and transitive. A **well-quasi-ordering** is a quasi-ordering such that any infinite sequence of elements x_0, x_1, x_2, \dots contains an increasing pair $x_i \leq x_j$ with $i < j$.

Let \mathbf{C} be a small directed category. Write $\mathbf{C}_x = \bigcup_y \text{Mor}_{\mathbf{C}}(x, y)$. If $f : x \rightarrow y$ and $g : x \rightarrow z$ are elements of \mathbf{C}_x then we write $f \leq g$ if there is a commutative triangle

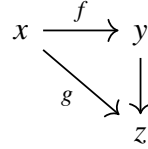

We call this quasi-order on \mathbf{C}_x the **divisibility order**. It is intrinsic to \mathbf{C} . An **admissible order** on \mathbf{C}_x is a well-order \leq such that if $f \leq f'$ then $gf \leq gf'$ whenever this makes sense. Admissible orders are not intrinsic to \mathbf{C} : they are extra structure.

Definition 46. We call \mathbf{C} **Gröbner** if each divisibility order \mathbf{C}_x is a well-quasi-order and each \mathbf{C}_x admits an admissible order.

Definition 47. Let $i : \mathbf{C}' \rightarrow \mathbf{C}$ be a functor. We say that i has **property (F)** if for each principal projective $P_x = \mathbb{C}\mathbf{C}(x, -)$ in $\text{Rep}(\mathbf{C})$, the \mathbf{C}' -representation i^*P_x is finitely generated.

Definition 48. A category \mathbf{C} is **quasi-Gröbner** if there is a Gröbner category \mathbf{C}' and an essentially surjective functor $\mathbf{C}' \rightarrow \mathbf{C}$ satisfying property (F).

Theorem 49. *The category \mathbf{PT} is Gröbner and the forgetful functor $\mathbf{PT} \rightarrow \mathbf{T}$ is essentially surjective and has property (F).*

Theorem 49 implies that \mathbf{T} is quasi-Gröbner. We refer the reader to [SS17] where the theory of Gröbner categories is developed.

5.4 A relative version of Kruskal's tree Theorem

We define a sequence of trees $B_1, B_2, B_3, B_4, \dots$ as follows: B_n is the graph with vertex set $\{*\} \cup \{1, \dots, n\}$ and edges $(i, *)$. Diagrammatically, we have

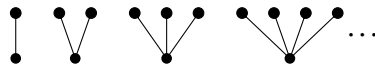

These planar rooted trees form building blocks in the category **FPT**.

Lemma 50. Let T be a planar rooted tree. Let v be a vertex of T . Let T_v be the sub tree of T which contains everything above and including v . Let T^v be the sub tree of T obtained by removing everything in T_v strictly above v . Then we have the following pushout square in **FPT**:

$$\begin{array}{ccc} T_v & \longrightarrow & T \\ \uparrow & & \uparrow \\ v & \longrightarrow & T^v \end{array}$$

Proof. To define a morphism $T \rightarrow U$, we need to send edges in T to paths in U so that domains and codomains are preserved. Since every edge in T is contained in either T_v or T^v , the lemma follows. \square

Example 51. Here is an example of such a pushout square:

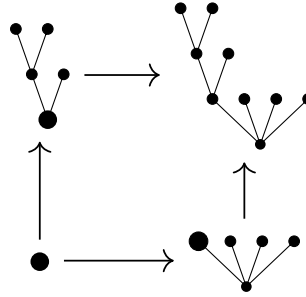

Lemma 52. Assume that T is a planar rooted tree and v_1, \dots, v_n are the vertices with distance 1 from the root. Then T is a colimit of the following diagram (that we have only drawn for $n = 3$):

$$\begin{array}{ccccc} T_{v_1} & & T_{v_2} & & T_{v_3} \\ \uparrow & & \uparrow & & \uparrow \\ v_1 & & v_2 & & v_3 \\ & \searrow & \downarrow & \swarrow & \\ & & B_3 & & \end{array}$$

Proof. This follows by repeated application of Lemma 50. \square

Lemma 53. We have a natural isomorphism

$$\text{Mor}_{\mathbf{FPT}}(B_n, T) = \left\{ \begin{array}{l} \text{distinct vertices } v, v_1, \dots, v_n \in T \text{ such that} \\ v_i \leq v \text{ in the tree order, the } v_i \text{ are pairwise} \\ \text{incomparable in the tree order and } v_1 \triangleleft \\ v_2 \triangleleft \dots \triangleleft v_n \text{ in the depth-first order} \end{array} \right\}$$

Proof. To specify a map out of B_n inside **FPT**, we need to specify the images of the root and leaves subject to planar ordering. \square

Let T be a planar rooted tree. Define \mathbf{PT}_T to be the set of morphisms in **PT** with domain T . If $f, g \in \mathbf{PT}_T$, we define $f \leq g$ if there is a commutative diagram

$$\begin{array}{ccc} T & \xrightarrow{f} & U \\ & \searrow g & \downarrow \\ & & V \end{array}$$

in the category **PT**. Equivalently, $f \leq g$ if there is a morphism h such that $g = hf$. This is called the divisibility quasi-order on \mathbf{PT}_T . Now we can state the relative version of Kruskal's tree Theorem:

Theorem 54. *The quasi-order on \mathbf{PT}_T is a well-quasi-order.*

The $T = \bullet$ case is very similar to Kruskal's tree Theorem. Indeed, Lemma 55 is proved by Draisma in [Dra14]. We include a proof to establish notation and demonstrate the main proof technique in the easiest case.

Lemma 55. *Theorem 54 is true when $T = \bullet$.*

Proof. We use the Nash–Williams theory of good/bad sequences that is explained in [Die10, Chapter 12]. We call a sequence x_0, x_1, x_2, \dots **good** if there exist indices $i < j$ such that $x_i \leq x_j$. Otherwise, the sequence is called **bad**. Suppose that \mathbf{PT}_\bullet is not well-quasi-ordered. Given $n \in \mathbb{N}$, assume inductively that we have chosen a sequence T_0, \dots, T_{n-1} of planar rooted trees such that some bad sequence of planar rooted trees starts with T_0, \dots, T_{n-1} . Choose T_n with a minimal number of vertices such that some bad sequence starts T_0, T_1, \dots, T_n . Then $(T_n)_{n \in \mathbb{N}}$ is a bad sequence. We call (T_n) a minimal bad sequence. Let v_1, \dots, v_d be the vertices in T_n whose distance from the root is 1, ordered with respect to the depth-first ordering. Let $A_n = T_{n,v_1} T_{n,v_2} \dots T_{n,v_n}$. If we think of each sequence A_n as a set, we can define $A = \cup_n A_n$. We claim that A is well-quasi-ordered. Let (U_k) be a sequence in A . Then $U_k \in A_{n(k)}$, so we have a morphism $U_k \rightarrow T_{n(k)}$ in **FPT**. This morphism does not preserve the root, but we can modify what the morphism does on the root vertex in the following way:

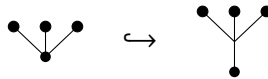

This allows us to convert $U_k \rightarrow T_{n(k)}$ into a morphism which witnesses $U_k \leq T_{n(k)}$. Choose p

so that $n(p)$ is the smallest element of $\{n(k)\}$. Then we have the following sequence

$$T_0, \dots, T_{n(p)-1}, U_p, U_{p+1}, \dots$$

By the minimality of (T_n) , it must have a good pair. If $T_i \leq U_j$ then we have $T_i \leq T_{n(j)}$. This is a contradiction because $i < n(p) \leq n(j)$. Therefore there must be a good pair in (U_k) . Since our choice of sequence in A was arbitrary, it follows that A is well-quasi-ordered. Consider the following sequence of words in A :

$$A_0, A_1, A_2, \dots$$

By Higman's Lemma, we must have $A_i \leq A_j$ for some $i < j$. What this means is that there is an order preserving injection $\phi : A_i \rightarrow A_j$ such that $U \leq \phi(U)$ for each $U \in A_i$. This gives us $T_i \leq T_j$ which is a contradiction. \square

Lemma 56. *Theorem 54 is true when $T = B_n$.*

Proof. The proof is by induction on n . The base case is $n = 1$. Elements in \mathbf{PT}_{B_1} are planar rooted trees with a distinguished non-root vertex and $T \leq U$ if there is a morphism $T \rightarrow U$ preserving the root and the distinguished non-root vertex. Choose a minimal bad sequence (T_n) in \mathbf{PT}_{B_1} . Define A_n as in Lemma 55. We can break the sequence A_n up as $L_n U_n R_n$ where U_n is the tree containing the distinguished vertex, L_n is the sequence of trees coming before U_n and R_n is the sequence of trees coming after U_n in the depth first ordering. There are two cases we need to consider:

1. Suppose that for an infinite subsequence (U_{n_k}) of (U_n) , the distinguished vertex in T_{n_k} is the root of U_{n_k} . Consider the following sequence

$$(L_{n_1}, U_{n_1}, R_{n_1}), (L_{n_2}, U_{n_2}, R_{n_2}), \dots$$

A product of well-quasi-orders is a well quasi-order. By Lemma 55, there must be a good pair $(L_{n_i}, U_{n_i}, R_{n_i}) \leq (L_{n_j}, U_{n_j}, R_{n_j})$ which gives us $T_{n_i} \leq T_{n_j}$ in \mathbf{PT}_{B_1} . This is a contradiction.

2. Suppose that for an infinite subsequence (U_{n_k}) of (U_n) , the distinguished vertex in T_{n_k} is not the root of U_{n_k} . The obvious morphism $U_{n_k} \rightarrow T_{n_k}$ does not preserve roots, but we can use the same trick as in Lemma 55 to get $U_{n_k} \leq T_{n_k}$ in \mathbf{PT}_{B_1} . Since we started with a minimal bad sequence, $\{U_{n_k}\}$ must be well-quasi-ordered, therefore the sequence

$$(L_{n_1}, U_{n_1}, R_{n_1}), (L_{n_2}, U_{n_2}, R_{n_2}), \dots$$

must have a good pair $(L_{n_i}, U_{n_i}, R_{n_i}) \leq (L_{n_j}, U_{n_j}, R_{n_j})$ which gives us $T_{n_i} \leq T_{n_j}$ in \mathbf{PT}_{B_1} . This is a contradiction.

One of these two cases must occur. Therefore we have proved that \mathbf{PT}_{B_1} is well-quasi-ordered. Now assume that \mathbf{PT}_{B_i} is well-quasi-ordered for $i < n$. We prove that \mathbf{PT}_{B_n} is well-quasi-ordered. Elements of \mathbf{PT}_{B_n} are planar rooted trees with n distinguished non-root vertices v_1, \dots, v_n that are incomparable in the tree order and ordered in the depth-first order. We have $T \leq U$ if there is a morphism $T \rightarrow U$ in \mathbf{FPT} that preserves the root and the distinguished non root vertices. Assume that (T_n) is a minimal bad sequence in \mathbf{PT}_{B_n} . As usual, form the sequence (A_n) . Define $\omega(A_n)$ as follows: replace each tree in A_n with the number of distinguished vertices of T_n it contains, then delete the zeros. By the pigeonhole principle

$$\omega(A_1), \omega(A_2), \omega(A_3), \dots$$

must contain some sequence m_1, \dots, m_d an infinite number of times. Let (T_{n_k}) be the corresponding subsequence of (T_n) . We must now consider two cases:

1. Suppose $d = 1$. Write $A_{n_k} = L_{n_k} U_{n_k} R_{n_k}$ where U_{n_k} contains all of the distinguished vertices in T_{n_k} . If there is an infinite subsequence where the root of U_{n_k} is not distinguished, then use a minimal bad sequence argument to get a contradiction. If there is an infinite subsequence where the root of U_{n_k} is distinguished, then use the induction hypothesis to get a contradiction.
2. If $d > 1$ then write

$$A_{n_k} = L_{n_k}^0 U_{n_k}^1 L_{n_k}^1 \dots U_{n_k}^d L_{n_k}^d$$

where $U_{n_k}^i$ has m_i of the distinguished vertices. Now use the induction hypothesis to get a contradiction.

□

Proof of Theorem 54. We induct on the number of vertices in T . Lemma 56 is the base case. Choose a non-root vertex v in T that has valence ≥ 2 . Choose a sequence $(\phi_n : T \rightarrow U_n)$ in \mathbf{PT}_T . Then we get sequences $\phi_{n,v} : T_v \rightarrow U_{n,\phi_n(v)}$ and $\phi_n^v : T^v \rightarrow U_n^{\phi_n(v)}$ in \mathbf{PT}_{T_v} and \mathbf{PT}_{T^v} respectively. By induction, there must be a good pair $(\phi_{i,v}, \phi_i^v) \leq (\phi_{j,v}, \phi_j^v)$. This induces $\phi_i \leq \phi_j$ which completes the proof. □

5.5 Proof of Main Theorem

In this section, we prove that \mathbf{PT} is a Gröbner category and that the forgetful functor $\mathbf{PT} \rightarrow \mathbf{T}$ has property (F) and is essentially surjective. Theorem 54 says that the divisibility order on \mathbf{PT}_T is a well-quasi-order. Therefore, to prove that \mathbf{PT} is Gröbner, we need to construct admissible orders on each \mathbf{PT}_T . Let T, U be planar rooted trees and choose a morphism $\phi : T \rightarrow U$ in \mathbf{PT} . If e is an edge in T , label every edge in the path $\phi(e)$ with the distance between $\text{target}(e)$ and $\text{root}(T)$ in T . (edges point towards the root). Now we go on a clockwise depth-first tree walk along U (depth-first tree walks are defined in [Sa99, chapter 5]). As we are traveling, record the path as follows:

1. If we travel up an edge marked with an i , write $($
 $$ _{i}
2. If we travel down an edge marked with an i , write $)$
 $$ _{i}
3. If we travel up an unmarked edge, write $($
4. If we travel down an unmarked edge, write $)$.

The resulting string is called the **Catalan word** of ϕ .

Example 57. consider the map:

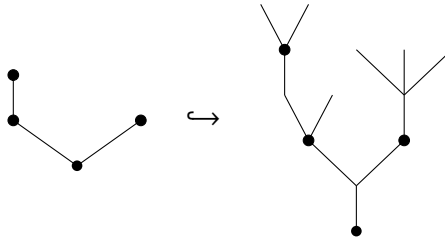

Its Catalan word is

$$\begin{array}{ccccccc} (((((O)))O)((O))) & & & & & & \\ 0011 & 11 & 00 & & & & 00 \end{array}$$

If $T = \bullet$ then we recover the the standard bijection between planar rooted trees and strings of balanced brackets which is described in [Sa99, chapter 5].

Lemma 58. *The mapping $\phi \mapsto$ Catalan word is injective.*

Proof. We can reproduce ϕ from its Catalan word as follows. The top row of parentheses gives the target. The bottom row of numbers tells us how the domain is mapped in, and also gives the domain since all tree maps are fully faithful. \square

We use Catalan words to equip each set \mathbf{PT}_T with an admissible order. Given a Catalan word, build the tuple (p, n) where p is the top row and n is the second row. We order the alphabets in the following way:

$$\begin{aligned} &) < (\\ & - < 0 < 1 < 2 < 3 < \dots \end{aligned}$$

Order words in the parentheses alphabet using the length lexicographic ordering. Order words in $\{-, 0, 1, 2, \dots\}$ using lexicographic ordering. Given two Catalan words $(p, n), (p', n')$, define $(p, n) < (p', n')$ if $p < p'$ or $p = p'$ and $n < n'$.

Lemma 59. *Let $f, g : T \rightarrow U$ be morphisms in \mathbf{PT} such that $f < g$ with respect to the above Catalan word ordering. Let $h : U \rightarrow V$ be a morphism. Then $hf < hg$.*

Proof. First we interpret $f < g$. When we go on a clockwise depth-first tree walk along U , the first time we notice a difference in the edge labeling, the label for g is larger than the label for f . Now go on a clockwise depth-first tree walk along V labeled by hf and hg . The first difference that we notice is going to be induced by the difference we noticed on our walk along U and the label for hg will be bigger than the label for hf because the labels are mapped from U . \square

This completes the construction of admissible orders on each \mathbf{PT}_T . Therefore we have proved that \mathbf{PT} is Gröbner. To conclude the proof of Theorem 49, we need to prove that the forgetful functor $i : \mathbf{PT} \rightarrow \mathbf{T}$ is essentially surjective and has property (F). Let $J : \mathbf{PT} \rightarrow \mathbf{T}$ be the functor which forgets the plane ordering. Since every rooted tree can be drawn on the plane it follows that J is essentially surjective. Let U be a rooted tree and V a planar rooted tree. Then we have

$$\mathbf{T}(U, J(V)) = \mathbf{PT}(U_1, V) \sqcup \mathbf{PT}(U_2, V) \sqcup \dots \sqcup \mathbf{PT}(U_e, V)$$

where U_1, \dots, U_e are all the planar representations of U . This implies that

$$J^* P_U = \bigoplus_{i=1}^e P_{U_i}$$

which proves that J has property (F).

BIBLIOGRAPHY

- [BH10] John Baez and John Huerta. The algebra of grand unified theories. *Bull. Amer. Math. Soc. (N.S.)*, 47(3):483–552, 2010.
- [CEF15] Thomas Church, Jordan S. Ellenberg, and Benson Farb. FI-modules and stability for representations of symmetric groups. *Duke Math. J.*, 164(9):1833–1910, 2015.
- [CFS95] J. Scott Carter, Daniel E. Flath, and Masahico Saito. *The classical and quantum 6j-symbols*, volume 43 of *Mathematical Notes*. Princeton University Press, Princeton, NJ, 1995.
- [Die10] Reinhard Diestel. *Graph theory*, volume 173 of *Graduate Texts in Mathematics*. Springer, Heidelberg, fourth edition, 2010.
- [Dra14] Jan Draisma. Noetherianity up to symmetry. In *Combinatorial algebraic geometry*, volume 2108 of *Lecture Notes in Math.*, pages 33–61. Springer, Cham, 2014.
- [EGNO15] Pavel Etingof, Shlomo Gelaki, Dmitri Nikshych, and Victor Ostrik. *Tensor categories*, volume 205 of *Mathematical Surveys and Monographs*. American Mathematical Society, Providence, RI, 2015.
- [Fre13] Daniel S. Freed. The cobordism hypothesis. *Bull. Amer. Math. Soc. (N.S.)*, 50(1):57–92, 2013.
- [JK81] Gordon James and Adalbert Kerber. *The representation theory of the symmetric group*, volume 16 of *Encyclopedia of Mathematics and its Applications*. Addison-Wesley Publishing Co., Reading, Mass., 1981. With a foreword by P. M. Cohn, With an introduction by Gilbert de B. Robinson.
- [JS91] André Joyal and Ross Street. The geometry of tensor calculus. I. *Adv. Math.*, 88(1):55–112, 1991.
- [LR97] Robert Leduc and Arun Ram. A ribbon Hopf algebra approach to the irreducible representations of centralizer algebras: the Brauer, Birman-Wenzl, and type A Iwahori-Hecke algebras. *Adv. Math.*, 125(1):1–94, 1997.

- [LZ06] G. I. Lehrer and R. B. Zhang. Strongly multiplicity free modules for Lie algebras and quantum groups. *J. Algebra*, 306(1):138–174, 2006.
- [ML98] Saunders Mac Lane. *Categories for the working mathematician*, volume 5 of *Graduate Texts in Mathematics*. Springer-Verlag, New York, second edition, 1998.
- [NC00] Michael A. Nielsen and Isaac L. Chuang. *Quantum computation and quantum information*. Cambridge University Press, Cambridge, 2000.
- [Olv87] Peter J. Olver. Invariant theory and differential equations. In *Invariant theory*, volume 1278 of *Lecture Notes in Math.*, pages 62–80. Springer, Berlin, 1987.
- [Pen71] Roger Penrose. Applications of negative dimensional tensors. In *Combinatorial Mathematics and its Applications (Proc. Conf., Oxford, 1969)*, pages 221–244. Academic Press, London, 1971.
- [Pen05] Roger Penrose. *The road to reality*. Alfred A. Knopf, Inc., New York, 2005. A complete guide to the laws of the universe.
- [Ram03] Arun Ram. Skew shape representations are irreducible. In *Combinatorial and geometric representation theory (Seoul, 2001)*, volume 325 of *Contemp. Math.*, pages 161–189. Amer. Math. Soc., Providence, RI, 2003.
- [Ric86] Günther Richter. Noetherian semigroup rings with several objects. In *Group and semigroup rings (Johannesburg, 1985)*, volume 126 of *North-Holland Math. Stud.*, pages 231–246. North-Holland, Amsterdam, 1986.
- [Rie14] Emily Riehl. *Categorical homotopy theory*, volume 24 of *New Mathematical Monographs*. Cambridge University Press, Cambridge, 2014.
- [Sa99] Richard P. Stanley and and. *Enumerative combinatorics. Vol. 2*, volume 62 of *Cambridge Studies in Advanced Mathematics*. Cambridge University Press, Cambridge, 1999. With a foreword by Gian-Carlo Rota and appendix 1 by Sergey Fomin.
- [Sel11] P. Selinger. A survey of graphical languages for monoidal categories. In *New structures for physics*, volume 813 of *Lecture Notes in Phys.*, pages 289–355. Springer, Heidelberg, 2011.
- [Ser01] Jean-Pierre Serre. *Complex semisimple Lie algebras*. Springer Monographs in Mathematics. Springer-Verlag, Berlin, 2001. Translated from the French by G. A. Jones, Reprint of the 1987 edition.
- [Sno13] Andrew Snowden. Syzygies of Segre embeddings and Δ -modules. *Duke Math. J.*, 162(2):225–277, 2013.
- [SS16] Steven V. Sam and Andrew Snowden. GL-equivariant modules over polynomial rings in infinitely many variables. *Trans. Amer. Math. Soc.*, 368(2):1097–1158, 2016.

- [SS17] Steven V. Sam and Andrew Snowden. Gröbner methods for representations of combinatorial categories. *J. Amer. Math. Soc.*, 30(1):159–203, 2017.
- [Wan10] Zhenghan Wang. *Topological quantum computation*, volume 112 of *CBMS Regional Conference Series in Mathematics*. Published for the Conference Board of the Mathematical Sciences, Washington, DC; by the American Mathematical Society, Providence, RI, 2010.